

TRE 701 - Multifunction time relay

Page 9-2



- Multifunction multitime time relay
- Wide time ranges
- Many varieties acc. to operating voltages and the number of output contacts
- CE

TRE 702 - Multifunction T1-T2 time relay

Page 9-4



- Multifunction T1-T2 time relay
- Wide time ranges
- Many varieties acc. to operating voltages and the number of output contacts
- Possibility of setting extremely asymmetrical T1-T2 time functions
- CE

TRE 703 - One-function one-time relay

Page 9-6



- One-function one-time relay
- For more sensitive applications
- Many varieties acc. to function, time rang, operating voltages and the number of output contacts
- CE

TRE 704 - Star-delta switch

Page 9-8



- Star-delta switch
- Time T1 can be adjusted within the selected time range
- Many varieties acc. to function, time rang and operating voltages
- CE

TRE 705 - Bistable time relay

Page 9-10



- Bistable time relay with hold-on after power off
- Time T1 can be adjusted within the selected time range
- Many varieties acc. to function, time rang and operating voltages
- CE

TRE 706 - Staircase switch

Page 9-12



- Staircase switch
- Adjustable time range from 0.5 to 10 minutes
- Version B has possibility of multiplying ON time by factor 8
- CE

TRE 707 - Asimmetric cycler

Page 9-14



- Cycler with independent adjustable switch ON/OFF
- Wide time ranges
- 2 time functions
- Time scale divided into 10 time ranges
- CE

TRE 708 - Single-function time relay

Page 9-16



- Single-function and single-time relay
- Time switch
- Choise of 3 functions
- Universal voltage range AC/DC 12-240 V
- CE

TRE 709 - Delay ON star/delta

Page 9-18



- Delay ON of motors star/delta
- Time t1 (star)
- Many varieties acc. to function, time rang, operating voltages and the number of output contacts
- CE

TRE 710 - Multifunction time relay

Page 9-20



- Multifunction time relay
- 3 time functions controlled by supply voltage
- 3 time functions controlled by control input
- Time scale divided into 6 ranges
- Universal voltage range: AC 24-240 V, DC 24 V
- CE

TRE 711 - Multifunction time relay

Page 9-23



- Multifunction time relay
- 10 functions
- 10 time ranges
- Multi-voltage
- Output contacts:
1x changover/SPDT 16 A
- CE

TRE 712 - Multifunction time relay

Page 9-23



- Multifunction time relay
- 10 functions
- 10 time ranges
- Multi-voltage
- Output contacts:
3x changover/SPDT 8 A
- CE

TRE 811 - Digital multifunction time relay

Page 9-26



- Digital multifunction time relay
- 17 functions
- Time ranges 0.1 s - 999 hrs
- Universal power supply 24 - 240 V AC/DC
- Output contacts:
1x changover/SPDT 8 A
- CE

CRT - Plug-in time relay

Page 9-29



- Plug-in time relay
- 10 functions
- Time ranges 0.1 s - 10 days
- Universal supply voltage
12 - 240 V AC/DC
- Output contacts:
1x changover/SPDT 16 A or
2x changover/SPDT 8 A
- CE

NDR - Programmable digital relay

Page 9-31



- Programmable digital relay
- 10 - 16 functions
- Time ranges 0.01 s - 100 hrs
- Supply voltage
12 - 240 V AC/DC or 230 V AC
- Output contacts:
2x changover/SPDT 16 A
- CE

TIME RELAYS TRE SERIES ARE SUITABLE FOR MANY DIFFERENT APPLICATIONS. THEY CAN BE ONE-FUNCTION OR MULTIFUNCTION AND COVER FROM SIMPLE TO SOPHISTICATED TIME FUNCTIONS. THEY CAN BE DELIVERED IN MANY VARIETIES ACCORDING TO OPERATING VOLTAGES AND NUMBER OF OUTPUT CONTACTS. AMONG THEM ARE ALSO STAR-DELTA SWITCH, BISTABLE TIME RELAY AND STAIRCASE SWITCH.

TIME RELAYS - MULTIFUNCTION MULTITIME RELAY -TRE 701



TRE 701 IS A MULTIFUNCTION MULTITIME TIME RELAY WITH BUILD-IN MICROPROCESSOR TECHNOLOGY. IT COVERS MOST OF THE USER NEEDS. IT COMPREHENDS SIMPLE AND MORE SOPHISTICATED TIME FUNCTIONS WITH VERY WIDE TIME RANGES. IT CAN BE DELIVERED IN MANY VARIETIES ACCORDING TO OPERATING VOLTAGES AND THE NUMBER OF OUTPUT CONTACTS.

FUNCTION DESCRIPTION

- A:** A pulse after power-on or after the rising edge of trigger pulse S.
- B:** Delay after power-on or after the rising edge of trigger pulse S.
- C:** A pulse after power-on or after the rising edge of trigger pulse S. Retriggerable.
- D:** Delay after power-on or after the rising edge of trigger pulse S. Retriggerable.
- E:** The first edge of trigger pulse S turns relay on while the second edge starts counting down till relay off. Additional trigger S before the process is finished prolongs the on-state.
- F:** Each rising edge of trigger S appends additional period T to the time of on-state.
- G:** Pulsating operating with a starting pulse or pause which depends on the state of trigger S at power-on.
- H:** Bistable operating. Each rising edge of trigger S swaps the relay into the opposite state.
- I:** Prolonged pulse after power-on. The presence of trigger S temporarily stops counting.
- J:** Prolonged pause after power-on. The presence of trigger S temporarily stops counting.

Notes:

Functions A - D: If triggering at power-on is required, then the control signal S must be active.

When changing function, the relay must be powered OFF and ON again.

It is possible to upgrade the relay with some user-defined functions with one or two independent output relays (for larger quantities).

Type	Control supply (V)	Number of output contacts	Ordering No.	Weight (g)	Packaging (pcs)
TRE 701 1 12 V AC/DC	12	1	022.417.000.111	65	1
TRE 701 1 230 V AC	230	1	022.417.000.112	65	1
TRE 701 1 24-240 V AC/DC	24 -240	1	022.417.000.110	65	1
TRE 701 2 230 V AC	230	2	022.417.000.122	70	1
TRE 701 2 24-240 V AC/DC	24 -240	2	022.417.000.120	70	1
TRE 701 3 24-240 V AC/DC	24 -240	3	022.417.000.130	75	1

TIME RELAYS - MULTIFUNCTION MULTITIME RELAY -TRE 701

Type	TRE 701
Standards	EN 60669, EN 60256, EN 61000, EN 61010, EN 61812
Operating voltage (select one range)	230 V AC 12 V AC/DC 24 - 240 V AC/DC
Operating voltage range	-15%, +10%
Output contact	1 - 3 x 8 A / 250 V
Time ranges (time ranges selected with a microswitch)	seconds: 1, 10 minutes: 1, 10 hours: 1, 10, 100, 500
Min. duration of trigger pulse S	50 ms
Input resistance of control input S	100 kΩ
Time setting repeatability	< 1%
Nominal time range tolerance	1%
Operating temperature	0 ... 55 °C
Storage temperature	-25 ... 70 °C
Degree of protection	IP 20
Diameter of connection cable	2.2 mm max.
Mechanical endurance	> 10 ⁷ cycles

Connection diagram

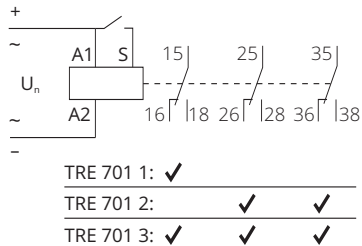

NOTE:

A combination with three contacts and 230 V AC operating voltage cannot be delivered.

Functions

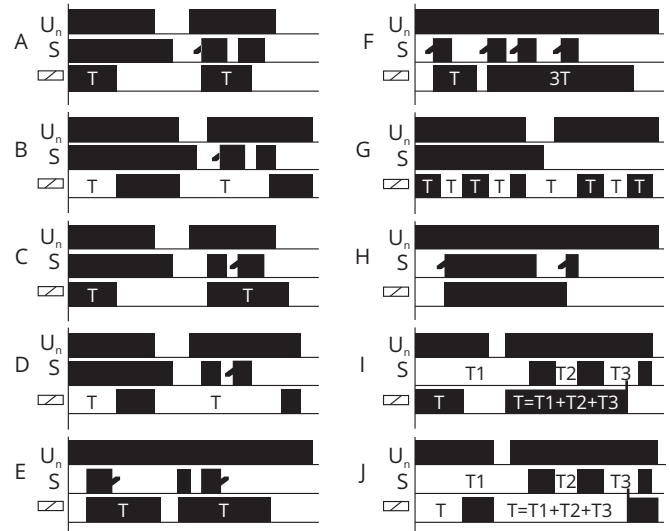

TIME RELAYS - MULTIFUNCTION TME RELAY - TRE 702



TRE 702 IS A MULTIFUNCTION T1-T2 TIME RELAY WITH BUILT-IN MICROPROCESSOR TECHNOLOGY. IT COVERS MOST OF THE USER NEEDS. THE TIME RELAY COMPREHENDS SIMPLE AND MORE SOPHISTICATED TIME FUNCTIONS WITH VERY WIDE TIME RANGES. IT CAN BE DELIVERED IN MANY VARIETIES ACCORDING TO OPERATING VOLTAGES AND THE NUMBER OF OUTPUT CONTACTS. IT EXCELS IN THE POSSIBILITY OF SETTING EXTREMELY ASYMMETRICAL T1-T2 TIME FUNCTIONS.

FUNCTION DESCRIPTION

- A:** A pulse after power-on or after the rising edge of trigger pulse S. Eventual signals S occurring before time T expiry have no influence.
- B:** Delay after power-on or after the rising edge of trigger pulse S. Eventual signals S occurring before time T expiry have no influence.
- C:** A pulse after power-on or after the rising edge of trigger pulse S. Retriggerable.
- D:** Delay after power-on or after rising edge of trigger pulse S. Retriggerable.
- E:** The first edge of trigger pulse S turns relay on while the second edge starts counting down till relay off. Additional trigger S prolongs the on-state before the process is finished.
- F:** Prolonged pulse after power-on. The presence of trigger S temporarily stops counting.
- G:** Pulsating operating with a non-equal pulse-pause rate. A starting pulse or a pause which depends on the state of trigger S at power-on.
- H:** After the rising edge of trigger S, the device waits for period T1 and the relay is activated (if trigger S is still present). After period T2, it is deactivated. If the trigger signal is shorter than period T1, the relay does not activate at all. If trigger S reappears during period T2, it has no influence.
- I:** After the rising edge of trigger S, the device waits for period T1 and the relay is activated (if the trigger S is still present). At the falling edge of trigger S the second counting starts and when it reaches T2, the relay is deactivated. If the trigger signal is shorter than period T1, the relay does not activate at all. If trigger S reappears during period T2, it has no influence.
- J:** The rising edge of trigger S activates the relay for period T1. The falling edge of trigger S activates the relay for period T2. If trigger S falls down during period T1, period will be cancelled. If trigger S reappears during period T2, it has no influence.

Notes:

Functions A - D: If triggering at power-on is required, then the control signal S must be active.

When changing function, the relay must be powered OFF and ON again.

For larger quantities, it is possible to upgrade the relay with some user-defined functions by means of one or two independent output relays.

Type	Control supply (V)	Number of output contacts	Ordering No.	Weight (g)	Packaging (pcs)
TRE 702 1 12 V AC/DC	12	1	022.417.000.211	65	1
TRE 702 1 230 V AC	230	1	022.417.000.212	65	1
TRE 702 1 24-240 V AC/DC	24-240	1	022.417.000.210	65	1
TRE 702 2 12 V AC/DC	12	2	022.417.000.221	70	1
TRE 702 2 230 V AC	230	2	022.417.000.222	70	1
TRE 702 2 24-240 V AC/DC	24-240	2	022.417.000.220	70	1
TRE 702 3 24-240 V AC/DC	24-240	3	022.417.000.230	75	1

TIME RELAYS - MULTIFUNCTION TIME RELAY - TRE 702

Type	TRE 702
Standards	EN 60669, EN 60256, EN 61000, EN 61010, EN 61812
Operating voltage (select one range)	230 V AC 12 V AC/DC
Operating voltage range	24 - 240 V AC/DC -15%, +10%
Output contact	1 - 3 x 8 A / 250 V
Time ranges (time ranges selected with a microswitch)	seconds: 1, 10 minutes: 1, 10 hours: 1, 10, 100, 500 T1, T2: 1h - 1 min, 10h - 10 min, 100h - 1h
Min. duration of trigger pulse S	50 ms
Input resistance of control input S	100 kΩ
Time setting repeatability	< 1%
Nominal time range tolerance	1%
Operating temperature	0 ... 55 °C
Storage temperature	-25 ... 70 °C
Degree of protection	IP 20
Diameter of connection cable	2.2 mm max.
Mechanical endurance	> 10 ⁷ cycles

Connection diagram

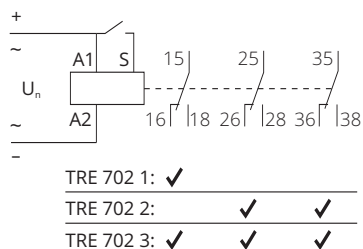

NOTE:

A combination with three contacts and 230 V AC operating voltage cannot be delivered.

Functions

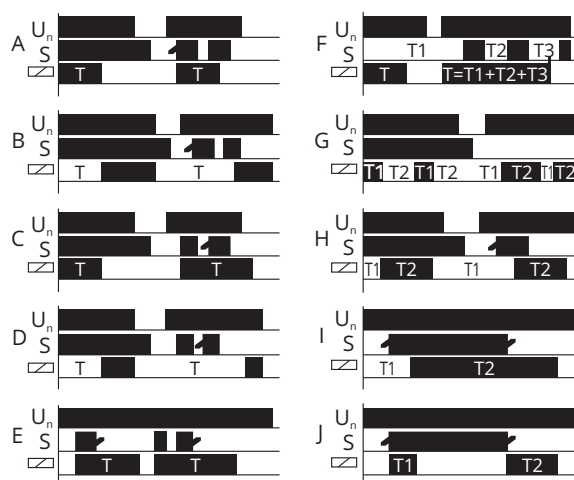

TIME RELAYS - ONE-FUNCTION ONE-TIME RELAY - TRE 703



TRE 703 IS A ONE-FUNCTION ONE-TIME RELAY USED FOR MORE SENSITIVE APPLICATIONS. IT CAN BE DELIVERED IN MANY VARIETIES ACCORDING TO FUNCTION, TIME RANGE, OPERATING VOLTAGE AND THE NUMBER OF OUTPUT CONTACTS.

FUNCTION DESCRIPTION

- A:** Pulse at power-on or at falling edge of control signal S
- B:** Pause at power-on or at falling edge of control signal S
- C:** Pulsating with starting pulse
- D:** Pulsating with starting pause

Notes:

Functions A - D: If triggering at power-on is required, then the control signal S must be active.

When changing function, the relay must be powered OFF and ON again.

For larger quantities, it is possible to upgrade the relay with some user-defined functions by means of one or two independent output relays.

Type	Control supply (V)	Number of output contacts	Function	Time range	Ordering No.	Weight (g)	Packaging (pcs)
TRE 703 1 24-240 V AC/DC A 3s	24 - 240	1	A	3s	022.417.000.301	65	1
TRE 703 1 24-240 V AC/DC B 3s	24 - 240	1	B	3s	022.417.000.302	65	1
TRE 703 1 24-240 V AC/DC A 15s	24 - 240	1	A	15s	022.417.000.305	65	1
TRE 703 1 24-240 V AC/DC B 15s	24 - 240	1	B	15s	022.417.000.306	65	1
TRE 703 1 24-240 V AC/DC C 15s	24 - 240	1	C	15s	022.417.000.307	65	1
TRE 703 1 24-240 V AC/DC A 3min	24 - 240	1	A	3min	022.417.000.313	65	1
TRE 703 1 24-240 V AC/DC A 3h	24 - 240	1	A	3hrs	022.417.000.325	65	1
TRE 703 1 230 V AC B 3s	230	1	B	3s	022.417.000.358	65	1
TRE 703 1 230 V AC A 15s	230	1	A	15s	022.417.000.361	65	1
TRE 703 1 230 V AC B 15s	230	1	B	15s	022.417.000.362	65	1
TRE 703 1 230 V AC C 15s	230	1	C	15s	022.417.000.363	65	1
TRE 703 1 230 V AC A 1min	230	1	A	1min	022.417.000.365	65	1
TRE 703 1 230 V AC B 1min	230	1	B	1min	022.417.000.366	65	1
TRE 703 1 230 V AC B 3min	230	1	B	3min	022.417.000.370	65	1
TRE 703 1 230 V AC A 15min	230	1	A	15min	022.417.000.373	65	1
TRE 703 1 230 V AC B 15min	230	1	B	15min	022.417.000.374	65	1
TRE 703 2 24-240 V AC/DC A 3s	24 - 240	2	A	3s	022.417.000.610	70	1
TRE 703 2 24-240 V AC/DC B 3s	24 - 240	2	B	3s	022.417.000.611	70	1
TRE 703 2 24-240 V AC/DC B 15s	24 - 240	2	B	15s	022.417.000.615	70	1
TRE 703 2 24-240 V AC/DC C 15s	24 - 240	2	C	15s	022.417.000.616	70	1
TRE 703 2 24-240 V AC/DC A 1min	24 - 240	2	A	1min	022.417.000.618	70	1
TRE 703 2 24-240 V AC/DC B 1min	24 - 240	2	B	1min	022.417.000.619	70	1
TRE 703 2 24-240 V AC/DC A 15min	24 - 240	2	A	15min	022.417.000.626	70	1
TRE 703 2 24-240 V AC/DC A 1h	24 - 240	2	A	1hrs	022.417.000.630	70	1
TRE 703 2 24-240 V AC/DC A 3h	24 - 240	2	A	3hrs	022.417.000.634	70	1

TIME RELAYS - ONE-FUNCTION ONE-TIME RELAY - TRE 703

Type	Control supply (V)	Number of output contacts	Function	Time range	Ordering No.	Weight (g)	Packaging (pcs)
TRE 703 2 12 V AC/DC A 15min	12	2	A	15min	022.417.000.654	70	1
TRE 703 2 12 V AC/DC A 1h	12	2	A	1h	022.417.000.658	70	1
TRE 703 2 230 V AC A 3s	230	2	A	3s	022.417.000.666	70	1
TRE 703 2 230 V AC B 15s	230	2	B	15s	022.417.000.671	70	1
TRE 703 2 230 V AC B 1min	230	2	B	1min	022.417.000.675	70	1
TRE 703 2 230 V AC B 15min	230	2	B	15min	022.417.000.683	70	1
TRE 703 3 24-240 V AC/DC B 15s	24 - 240	3	B	15s	022.417.000.145	75	1
TRE 703 3 24-240 V AC/DC B 1min	24 - 240	3	B	1min	022.417.000.149	75	1

Type	TRE 703
Standards	EN 60669, EN 60256, EN 61000, EN 61010, EN 61812
Operating voltage (select one range)	230 V AC 12 V AC/DC
Operating voltage range	24 - 240 V AC/DC -15%, +10%
Output contact	1 - 3 x 8 A / 250 V
Time ranges (time ranges selected with a microswitch)	seconds: 3, 15 minutes: 1, 3, 15 hours: 1, 3
Min. duration of trigger pulse S	50 ms
Input resistance of control input S	100 kΩ
Time setting repeatability	< 2%
Nominal time range tolerance	5%
Operating temperature	0 ... 55 °C
Storage temperature	-25 ... 70 °C
Degree of protection	IP 20
Diameter of connection cable	2.2 mm max.
Mechanical endurance	> 10 ⁷ cycles

Connection diagram

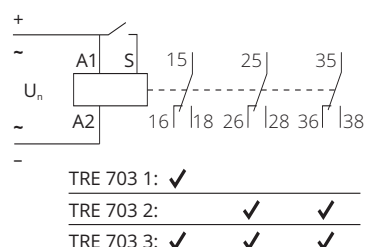

Functions

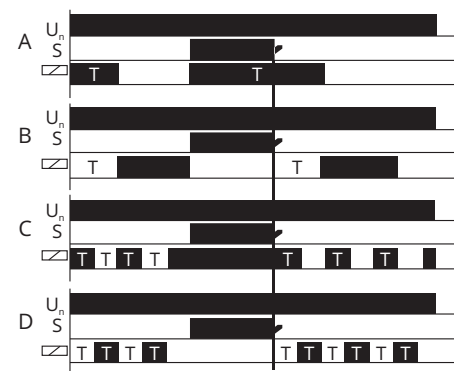

NOTE:
A combination with three contacts and 230 V AC operating voltage cannot be delivered.

TIME RELAYS - STAR-DELTA SWITCH - TRE 704



TRE 704 IS A STAR-DELTA SWITCH. TIME T1 CAN BE ADJUSTED WITHIN THE SELECTED TIME RANGE. IT CAN BE DELIVERED IN MANY VARIETIES ACCORDING TO TIME RANGE AND OPERATING VOLTAGE.

FUNCTION DESCRIPTION

- After power-on, the relay Y is activated for time T.
- After the pause. T2 = 100 ms, the relay Δ is activated.

Type	Control supply (V)	Number of output contacts	Time range	Ordering No.	Weight (g)	Packaging (pcs)
TRE 704 2 24-240 V AC/DC 10s	24 - 240	2	10s	022.417.000.401	65	1
TRE 704 2 230 V AC 10s	230	2	10s	022.417.000.403	65	1
TRE 704 2 24-240 V AC/DC 30s	24 - 240	2	30s	022.417.000.421	65	1
TRE 704 2 230 V AC 30s	230	2	30s	022.417.000.423	65	1
TRE 704 2 24-240 V AC/DC 60s	24 - 240	2	60s	022.417.000.431	65	1
TRE 704 2 12 V AC/DC 60s	12	2	60s	022.417.000.432	65	1
TRE 704 2 230 V AC 60s	230	2	60s	022.417.000.433	65	1
TRE 704 2 24-240 V AC/DC 120s	24 - 240	2	120s	022.417.000.441	65	1
TRE 704 2 230 V AC 120s	230	2	120s	022.417.000.443	65	1
TRE 704 2 24-240 V AC/DC 600s	24 - 240	2	600s	022.417.000.451	65	1
TRE 704 2 230 V AC 600s	230	2	120s	022.417.000.453	65	1

TIME RELAYS - STAR-DELTA SWITCH - TRE 704

Type	TRE 704
Standards	EN 60669, EN 60256, EN 61000, EN 61010, EN 61812
Operating voltage (select one range)	230 V AC 12 V AC/DC
Operating voltage range	24 - 240 V AC/DC -15%, +10%
Output contact	2 x 8 A / 250 V
Time ranges (select one range)	seconds: 10, 30, 60, 120, 600
Min. duration of trigger pulse S	50 ms
Time setting repeatability	< 2%
Nominal time range tolerance	5%
Operating temperature	0 ... 55 °C
Storage temperature	-25 ... 70 °C
Degree of protection	IP 20
Diameter of connection cable	2.2 mm max.
Mechanical endurance	> 10 ⁷ cycles

Connection diagram

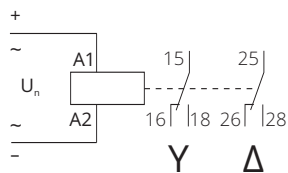

Functions

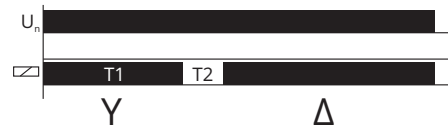

TIME RELAYS - BISTABLE TIME RELAY - TRE 705



TRE 705 IS A BISTABLE TIME RELAY WITH HOLD-ON AFTER POWER OFF. TIME T1 CAN BE ADJUSTED WITHIN THE SELECTED TIME RANGE. IT CAN BE DELIVERED IN MANY VARIETIES ACCORDING TO TIME RANGE AND OPERATING VOLTAGE.

FUNCTION DESCRIPTION

- A:** The relay is activated after power-on. After power-off, it remains activated for the period T.
- B:** The relay is activated at power-off and remains activated for the period T.

Type	Control supply (V)	Number of output contacts	Function	Time range	Ordering No.	Weight (g)	Packaging (pcs)
TRE 705 1 24-240 V AC/DC A 10s	24 - 240	1	A	10s	022.417.000.511	65	1
TRE 705 1 24-240 V AC/DC B 10s	24 - 240	1	B	10s	022.417.000.512	65	1
TRE 705 1 24-240 V AC/DC A 30s	24 - 240	1	A	30s	022.417.000.521	65	1
TRE 705 1 24-240 V AC/DC B 30s	24 - 240	1	B	30s	022.417.000.522	65	1
TRE 705 1 12 V AC/DC A 30s	12	1	A	30s	022.417.000.523	65	1
TRE 705 1 24-240 V AC/DC A 60s	24 - 240	1	A	60s	022.417.000.531	65	1
TRE 705 1 24-240 V AC/DC B 60s	24 - 240	1	B	60s	022.417.000.532	65	1
TRE 705 1 12 V AC/DC A 60s	12	1	A	60s	022.417.000.533	65	1
TRE 705 1 24-240 V AC/DC B 120s	24 - 240	1	B	120s	022.417.000.542	65	1
TRE 705 1 24-240 V AC/DC A 300s	24 - 240	1	A	300s	022.417.000.551	65	1
TRE 705 1 24-240 V AC/DC B 300s	24 - 240	1	B	300s	022.417.000.552	65	1

TIME RELAYS - BISTABLE TIME RELAY - TRE 705

Type	TRE 705
Standards	EN 60669, EN 60256, EN 61000, EN 61010, EN 61812
Operating voltage (select one range)	230 V AC 12 V AC/DC 24 - 240 V AC/DC
Operating voltage range	-15%, +10%
Output contact	6 A / 250 V
Time ranges (select one range)	seconds: 10, 30, 60, 120, 300
Min. duration of trigger pulse S	50 ms
Time setting repeatability	< 2%
Nominal time range tolerance	5%
Operating temperature	0 ... 55 °C
Storage temperature	-25 ... 70 °C
Degree of protection	IP 20
Diameter of connection cable	2.2 mm max.
Mechanical endurance	> 10 ⁷ cycles

Connection diagram

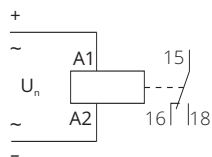

Functions



TIME RELAYS - STAIRCASE SWITCH - TRE 706



TRE 706 IS A STAIRCASE SWITCH. TIME CAN BE ADJUSTED IN THE RANGE FROM 0.5 TO 10 MINUTES. IT IS EDGE TRIGGERED, WHICH MEANS THAT IT IS BROKEN-SWITCH PROOF. ENHANCED VERSION B HAS THE POSSIBILITY OF MULTIPLYING ON TIME BY FACTOR 8. THIS FAST-ON FUNCTION IS ACTIVATED BY HOLDING THE SWITCH FOR PROLONGED TIME (6- TO 8 - SECOND). THIS IS VERY USEFUL AT CLEANING, REPAIRS ETC.

FUNCTION DESCRIPTION

- The signal S activates the relay for period T. If the duration of the signal S is longer than 6 seconds, the period T is prolonged by factor 8 (version B). This is indicated by changing the brightness of the control red LED.
- If the signal S reappears before the period T expires, the counting time starts again from the beginning.

9

Type	Control supply (V)	Number of output contacts	Function	Time range	Ordering No.	Weight (g)	Packaging (pcs)
TRE 706 1 230 V AC A	230	1	A	30s - 10min	022.417.000.601	65	1
TRE 706 1 230 V AC B	230	1	B	4 - 80min	022.417.000.602	65	1

ORDERING DATA

TIME RELAYS - STAIRCASE SWITCH - TRE 706

Type		TRE 706
Standards		EN 60669, EN 60256, EN 61000, EN 61010, EN 61812
Operating voltage		230 V AC
Operating voltage range		-15%, +10%
Input resistance of control input S		100 kΩ
Output contact		16 A / 250 V
Time ranges	Version A	30 s - 10 min
		ON - OFF
	Version B	4 - 80 min
		ON - OFF
Min. duration of trigger pulse S		50 ms
Time setting repeatability		< 2%
Nominal time range tolerance		5%
Operating temperature		0 ... 55 °C
Storage temperature		-25 ... 70 °C
Degree of protection		IP 20
Diameter of connection cable		2.2 mm max.
Mechanical endurance		> 10 ⁷ cycles

Connection diagram

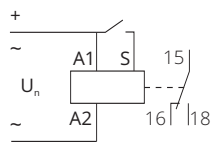

Functions

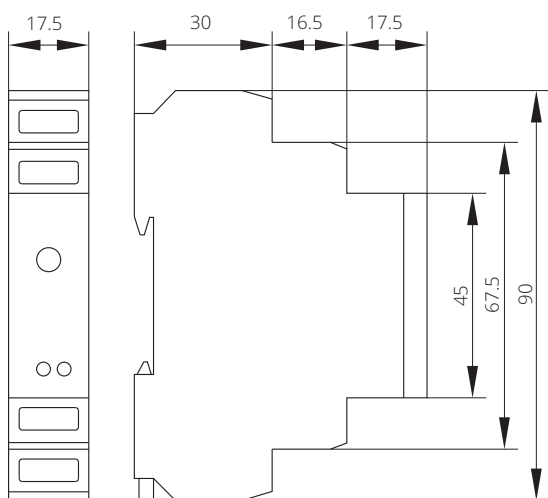
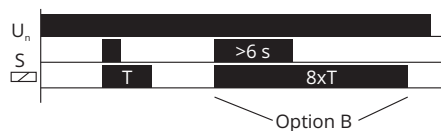

TIME RELAYS - ASYMMETRIC CYCLER - TRE 707



TRE 707 - ASYMMETRIC CYCLER USED FOR REGULAR ROOM VENTILATION, CYCLIC DEHUMIDIFICATION, LIGHT CONTROL, CIRCULATING PUMPS, NOON SIGNS, ETC.

FUNCTION DESCRIPTION

- Cycler with independent adjustable switch ON/OFF
- 2 time functions:
 1. Cycler beginning with pulse
 2. Cycler beginning with pause
- Function choice is done by an external jumper of terminals S-A1
- Time scale 0.1 - 100 days divided into 10 time ranges:
- (0.1 s - 1 s/1s - 10 s/ 0.1 min - 1min/ 1 min - 10 min/ 0.1 hrs - 1 hrs/1 hrs - 10 hrs/ 0.1 day - 1 day/ 1 day - 10 days/ 3 days - 30 days/ 10 days - 100 days)
- Rough time setting via rotary switch
- Voltage range: AC 230 V or AC/DC 12 - 240 V
- Output contact: 1x changeover/ SPDT 16 A
- Output indication: multifunction red LED
- 1-module, DIN rail mounting

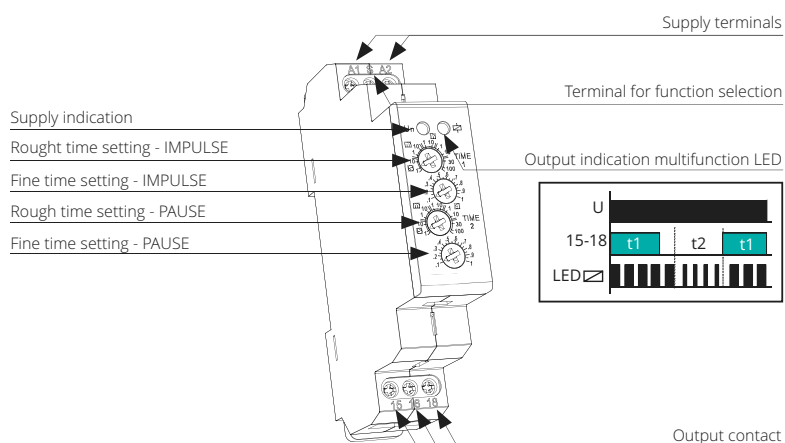

Type	Control supply (V)	Number of optput contacts	Time range	Ordering No.	Weight (g)	Packaging (pcs)
TRE 707 1 UNI	UNI	1	0.1s - 100 days	786.053.056	65	1
TRE 707 1 230 V AC	230	1	0.1s - 100 days	786.053.057	61	1

TIME RELAYS - ASYMMETRIC CYCLER - TRE 707

Type	TRE 707
Number of functions	2 (second function is chosen by connecting S-A1)
Supply terminals	A1 - A2
Voltage range	AC/DC 12 - 240 V (AC 50 - 60 Hz)
Burden	AC 0.7 - 3 VA / DC 0.5 - 1,7 W
Voltage range	AC 230 V / 50 - 60 Hz
Power input (apparent input/loss input)	AC max. 12 VA / 1.3 W
Supply voltage tolerance	-15 %; +10 %
Supply indication	green LED
Time scale	0.1 s - 100 days
Time setting	rotary switch and potentiometer
Time deviation	5 % - mechanical setting
Repeat accuracy	0.2 % - set value stability
Temperature coefficient	0.01 % / °C, at = 20 °C
OUTPUT	
Number of contacts	1x changeover/SPDT (AgNi / Silver Alloy)
Current rating	16 A / AC1
Breaking capacity	4000 VA / AC1, 384 W / DC
Inrush current	30 A / <3 s
Switching voltage	250 V AC1 / 24 V DC
Min. breaking capacity DC	500 mW
Output indication	multifunction red LED
Mechanical life	3 x 10 ⁷
Electrical life (resistive)	0.7 x 10 ⁶
Reset time	max. 150 ms
OTHER INFORMATION	
Operating temperature	-20 ... +55 °C
Storage temperature	-30 ... +70 °C
Electrical strength	4 kV (supply-output)
Operating position	any
Mounting	DIN rail EN 60715
Protection degree	IP 40 from front panel / IP 20 terminals
Overvoltage category	III.
Pollution degree	2
Terminal wire capacity	solid wire max. 1x 2.5 or 2x1.5 / with sleeve max. 1x2.5
Standards	EN 61812-1, EN 61010-1

Connection diagram

CYCLER BEGINNING WITH PULSE

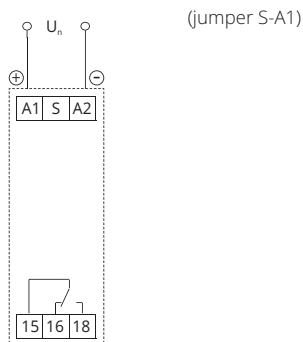

CYCLER BEGINNING WITH PAUSE



Functions

CYCLER BEGINNING WITH PULSE

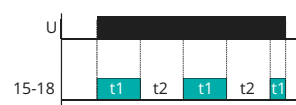

CYCLER BEGINNING WITH PAUSE

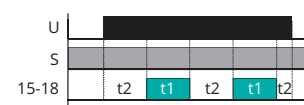

Symbol

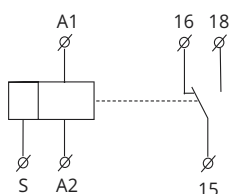

TIME RELAYS - SINGLE-FUNCTION TIME RELAY - TRE 708



TRE 708 - SINGLE-FUNCTION TIME RELAY USED FOR PUMP DECAY TIME AFTER SWITCHING HEATING OFF, SWITCHING OF FANS.



FUNCTION DESCRIPTION

- Single-function and single-time relay with possibility of fine time setting by a potentiometer (within the frames of a particular time range)
- Suitable for applications where function and time requirements are known
- Choice of 3 functions:
 1. ZR - Delay ON
 3. BL - Repeat Cycle
- Functions can be controlled by supply voltage or time scale control input.: (0.1 s - 1 s / 1 s - 10 s / 6 s - 60 s / 1 min - 10 min / 6 min - 60 min / 1 h - 10 hrs)
- Universal voltage range AC/DC 12 - 240 V
- Output contact: 1x changeover/ SPDT 16 A
- Red LED output indicator
- 1-MODULE, DIN rail mounting

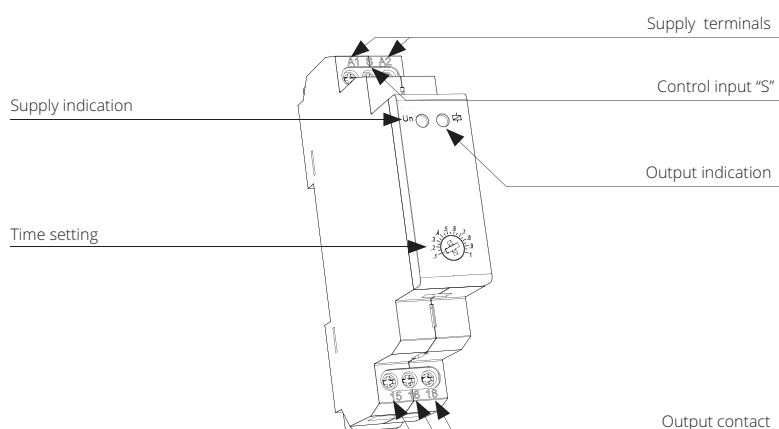

Type	Control supply (V)	Number of optput contacts	Time range	Ordering No.	Weight (g)	Packaging (pcs)
TRE 708 1 UNI BL 1s	UNI	1	0.1s - 100hrs	786.053.063	62	1
TRE 708 1 UNI BL 10s	UNI	1	0.1s - 100hrs	786.053.070	62	1
TRE 708 1 UNI ZRL 60s	UNI	1	0.1s - 100hrs	786.053.079	62	1
TRE 708/3 1 UNI ZR 60s	UNI	1	0.1s - 100hrs	786.053.080	62	1
TRE 708 1 UNI ZR 10s	UNI	1	0.1s - 100hrs	786.053.082	62	1

TIME RELAYS - SINGLE-FUNCTION TIME RELAY - TRE 708

Type	TRE 708
Number of functions	ZR - delay ON / BL- cyclcr 1:1
Supply terminals	A1 - A2
Voltage range	AC/DC 12 - 240 V (AC 50 - 60 Hz)
Burden	AC 0.7 - 3 VA / DC 0.5 - 1,7 W
Supply voltage tolerance	-15 %; +10 %
Supply indication	green LED
Time scale	0.1 s - 100 days
Time setting	potentiometer
Time deviation	5 % - mechanical setting
Repeat accuracy	0.2 % - set value stability
Temperature coefficient	0.01 % / °C, at = 20 °C
OUTPUT	
Number of contacts	1x changeover/SPDT (AgNi / Silver Alloy)
Current rating	16 A / AC1
Breaking capacity	4000 VA / AC1, 384 W / DC
Inrush current	30 A / <3 s
Switching voltage	250 V AC1 / 24 V DC
Min. breaking capacity DC	500 mW
Output indication	red LED
Mechanical life	3 x 10 ⁷
Electrical life (resistive)	0.7 x 10 ⁵
Reset time	max. 150 ms
CONTROL	
Consumption of input	AC 0.025 - 0.2 VA / DC 0.1 - 0.7 W
Load between S-A2	Yes
Control terminals	A1-S
Glow tubes connctions	Yes
Max. amount of glow lamps connected to controlling input	glow lamps cannot connected/NO
Impulse length	min. 25 ms / max. unlimited
Reset time	max. 150 ms
OTHER INFORMATION	
Operating temperature	-20 ... +55 °C
Storage temperature	-30 ... +70 °C
Electrical strength	4 kV (supply-output)
Operating position	any
Mounting	DIN rail EN 60715
Protection degree	IP 40 from front panel / IP 20 teminals
Overvoltage category	III.
Pollution degree	2
Terminal wire capacity	solid wire max. 1x 2.5 or 2x1.5 / with sleeve max. 1x2.5
Standards	EN 61812-1, EN 61010-1

Connection diagram

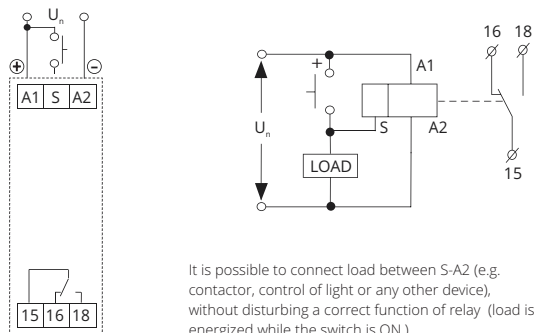

Functions

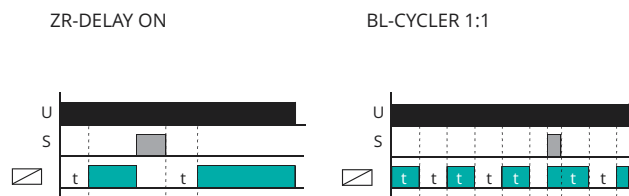

Note: The function ZR is controlled by supply voltage and control input ie. Once phase failure is detected and supply voltage is re applied, The relay automatically makes one cycle.

Symbol

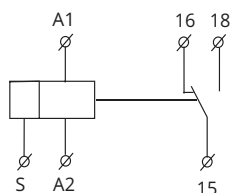

TIME RELAYS - DELAY ON STAR/DELTA - TRE 709



TRE 709 SERVES FOR DELAY ON OF MOTORS STAR/DELTA.



FUNCTION DESCRIPTION

- Time t1 (star)
 - time scale 0.1 s - 100 days divided into 10 time ranges
 - rough time setting by rotary switch
- Time t2 (delay) between / :
 - time scale 0.1 s - 1 s
 - fine time setting by potentiometer
- Voltage range: AC 230 V, AC/DC 12 - 240 V
- Output contact: 2x changeover/ DPDT 16A
- Output indication: multifunction red LED
- 1-MODULE, DIN rail mounting

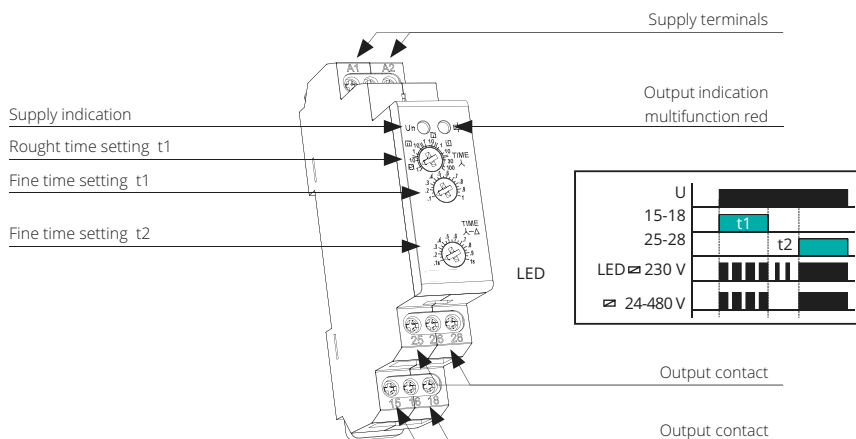

Type	Control supply (V)	Number of optput contacts	Time range	Ordering No.	Weight (g)	Packaging (pcs)
TRE 709 2 UNI 1s	UNI	2	1s	786.053.063	84	1

TIME RELAYS - DELAY ON STAR/DELTA - TRE 709

Type	TRE 709
Number of functions	1
Supply terminals	A1 - A2
Voltage range	AC/DC 12 - 240 V (AC 50 - 60 Hz)
Burden	AC 0.7 - 3 VA / DC 0.5 - 1,7 W
Supply voltage tolerance	-15 %; +10 %
Supply indication	green LED
Time scale	t1: 0.1s - 100 days; t2: 0.1 s - 1 s
Time setting	potentiometer
Time deviation	5 % - mechanical setting
Repeat accuracy	0.2 % - set value stability
Temperature coefficient	0.01 % / °C, at = 20 °C
OUTPUT	
Number of contacts	2x changeover (AgNi/Silver Alloy)
Current rating	16 A / AC1
Breaking capacity	4000 VA / AC1, 384 W / DC
Inrush current	30 A / <3 s
Switching voltage	250 V AC1 / 24 V DC
Min. breaking capacity DC	500 mW
Output indication	multifunction red LED
Mechanical life	3 x 10 ⁷
Electrical life (resistive)	0.7 x 10 ⁵
Reset time	max. 150 ms
OTHER INFORMATION	
Operating temperature	-20 ... +55 °C
Storage temperature	-30 ... +70 °C
Electrical strength	4 kV (supply-output)
Operating position	any
Mounting	DIN rail EN 60715
Protection degree	IP 40 from front panel / IP 20 terminals
Overvoltage category	III.
Pollution degree	2
Terminal wire capacity	solid wire max. 1x 2.5 or 2x1.5 / with sleeve max. 1x2.5
Standards	EN 61812-1, EN 61010-1

Symbol

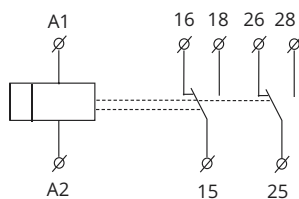

Functions

DELAY ON STAR/DELTA



Connection diagram

START UP OF MOTOR (λ-Δ)

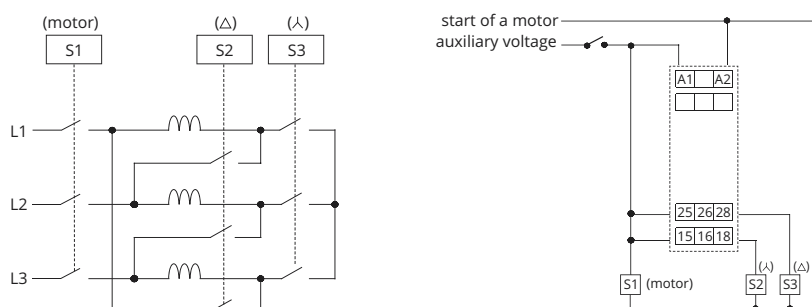

TIME RELAYS - MULTIFUNCTION TIME RELAY - TRE 710



TRE 710 - MULTIFUNCTION TIME RELAY CAN BE USED FOR ELECTRICAL APPLIANCES, CONTROL OF LIGHTS, HEATING, MOTORS, PUMPS AND FANS (10 FUNCTIONS, 10 TIME RANGES, MULTI-VOLTAGE, 16AMPS OR 3X8AMPS CONTACTS).



FUNCTION DESCRIPTION

- Multifunction time relay (6 functions and 6 time ranges)
- 6 functions:
 - 3 time functions controlled by supply voltage
 - 3 time functions controlled by control input
- Easy to use function and time-range setting by rotary switches
- Time scale 0.1 s - 10 hrs divided into 6 ranges: (0.1s - 1s/1 s-10 s / 0.1 min - 1 min / 1 min - 10 min / 0.1 hrs - 1 hrs / 1 hrs - 10 hrs)
- Universal voltage range AC 24 - 240 V, DC 24 V
- Output contact: 1x changeover/ SPDT 8 A
- Multifunction red LED output indicator flashes or shines depending of status
- 1-MODULE, DIN rail mounting

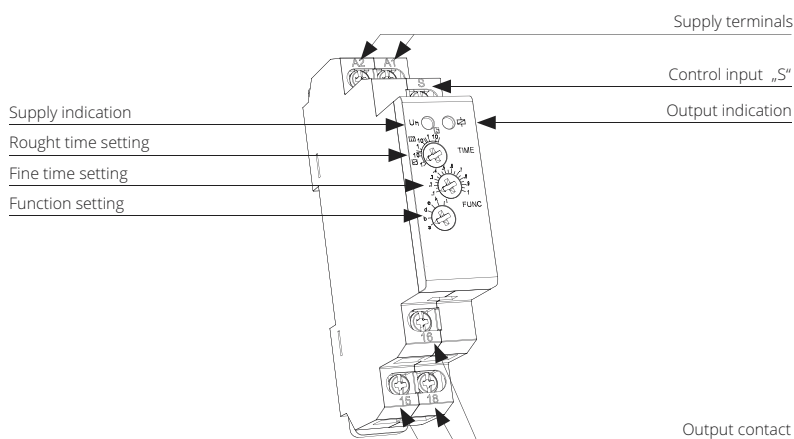

Type	Control supply (V)	Number of optput contacts	Time range	Ordering No.	Weight (g)	Packaging (pcs)
TRE 710 1 UNI	UNI	1	1s - 10hrs	786.053.063	69	1

TIME RELAYS - MULTIFUNCTION TIME RELAY - TRE 710

Type	TRE 710
Number of functions	6
Supply terminals	A1 - A2
Voltage range	AC/DC 12 - 240 V (AC 50 - 60 Hz)
Burden	AC 0.7 - 3 VA / DC 0.5 - 1,7 W
Supply voltage tolerance	-15 %; +10 %
Supply indication	green LED
Time scale	0.1 s - 10 hrs
Time setting	rotary switch and potentiometer
Time deviation	5 % - mechanical setting
Repeat accuracy	0.2 % - set value stability
Temperature coefficient	0.01 % / °C, at = 20 °C
OUTPUT	
Number of contacts	1x changeover/SPDT (AgNi / Silver Alloy)
Current rating	8 A / AC1
Breaking capacity	2500 VA / AC1, 240 W / DC
Inrush current	30 A / <3 s
Switching voltage	250 V AC1 / 24 V DC
Min. breaking capacity DC	500 mW
Output indication	multifunction red LED
Mechanical life	1 x 10 ⁷
Electrical life (resistive)	1 x 10 ⁵
CONTROL	
Control voltage	UNI
Control power input	AC 0.025 - 0.2 VA / DC 0.1 - 0.7 W
Load between S-A2	Yes
Control terminals	A1-S
Glow tubes connctions	No
Max. capacity of cable control	0.1 µF
Impulse length	min. 25 ms / max. unlimited
Reset time	max. 150 ms
OTHER INFORMATION	
Operating temperature	-20 ... +55 °C
Storage temperature	-30 ... +70 °C
Electrical strength	4 kV (supply-output)
Operating position	any
Mounting	DIN rail EN 60715
Protection degree	IP 40 from front panel / IP 20 terminals
Overvoltage category	III.
Pollution degree	2
Terminal wire capacity	solid wire max. 2x 2.5 mm ² max. 1x4 mm ² / with sleeve max. 1x2.5 mm ² , 2x1.5 mm ²
Standards	EN 61812-1, EN 61010-1

Connection diagram

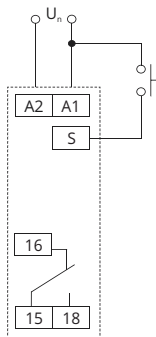

Symbol

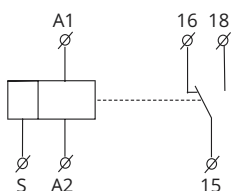

Functions

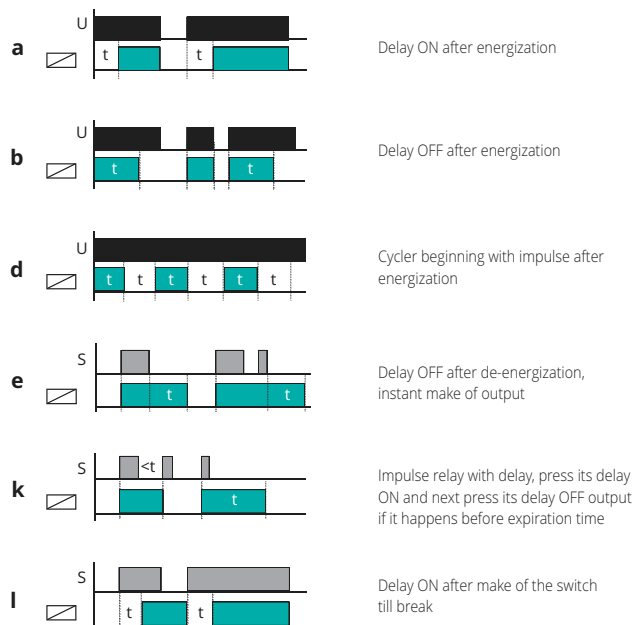

TIME RELAYS - MULTIFUNCTION TIME RELAY - TRE 711, TRE 712



TRE 711, TRE 712 - MULTIFUNCTION TIME RELAY CAN BE USED FOR ELECTRICAL APPLIANCES, CONTROL OF LIGHTS, HEATING, MOTORS, PUMPS AND FANS (10 FUNCTIONS (10 TIME RANGES, MULTI-VOLTAGE, 16 A OR 3x 8 A CONTACTS)).

FUNCTION DESCRIPTION

- Fulfills all requirements for time relays
- 10 functions:
 - 5 time functions controlled by supply voltage
 - 5 time functions controlled by supply voltage
 - 4 time functions controlled by control input
 - 1 function of latching relay
- Comfortable and well-arranged function and time-range setting by rotary switches
- Time scale 0.1 s - 10 days divided into 10 ranges: (0.1 s-1 s / 1 s-10 s / 0.1 min-1 min / 1 min-10 min / 0.1 hrs-1 hrs / 1 hrs-10 hrs / 0.1 day-1 day / 1 day-10 days / only ON / only OFF)
- **TRE 711, TRE 712:** - Universal supply voltage AC/DC 12 - 240 V or AC 230 V,
 - Output contact: **TRE 711:** 1x changeover/SPDT 16 A;
 - TRE 712:** 3 x changeover/SPDT 8 A
- **TRE 711 TO:** - Universal supply voltage AC 12 - 240 V AC 12 - 240 V, absolutely noise-less switching
 - 1x static contactless output (triac) 0.1.7 A (60 A / <10 ms), switches potential A1
- Multifunction red LED output indicator flashes or shines depending of status

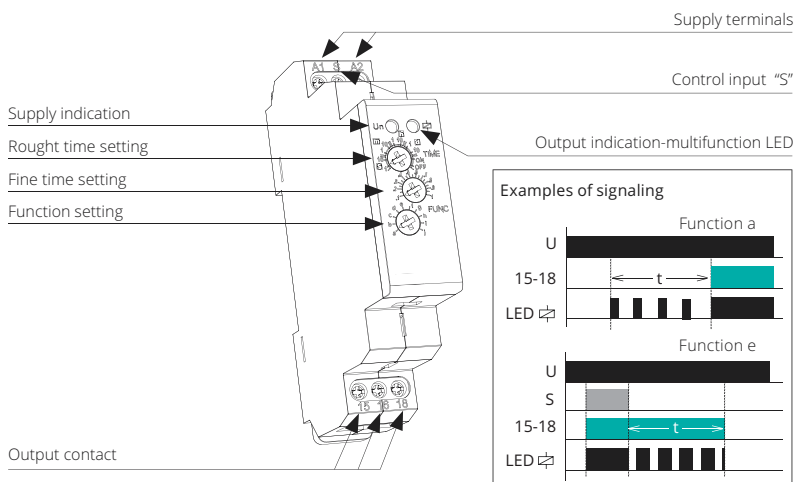

Type	Control supply (V)	Number of optput contacts	Time range	Ordering No.	Weight (g)	Packaging (pcs)
TRE 711 1 UNI	UNI	1	1s - 10days	786.053.058	64	1
TRE 711 1 230 V AC	230	1	1s - 10days	786.053.059	62	1
TRE 711 TO 1 UNI	UNI	1	1s - 10days	786.053.077	51	1
TRE 712 3 UNI	UNI	3	1s - 10days	786.053.060	89	1
TRE 711 3 230 V AC	230	3	1s - 10days	786.053.061	87	1

TIME RELAYS - MULTIFUNCTION TIME RELAY - TRE 711, TRE 712

Type	TRE 711	TRE 711 TO	TRE 712
Number of functions	10		
Supply terminals	A1 - A2		
Voltage range	AC/DC 12 - 240 V (AC 50 - 60 Hz)	AC 12 - 240 V (50 - 60 Hz)	AC/DC 12 - 240 V (AC 50 - 60 Hz)
Burden	AC 0.7 - 3 VA / DC 0.5 - 1,7 W	AC max. 0.35 VA	AC 0.7 - 3 VA / DC 0.5 - 1,7 W
Voltage range	AC 230 V / 50 - 60 Hz	x	AC 230 V / 50 - 60 Hz
Consumption (apparent/loss)	AC max. 12 VA / 1.3 W	x	AC max. 12 VA / 1.3 W
Supply voltage tolerance	-15 %; +10 %		
Supply indication	green LED		
Time scale	0.1 s - 10 days		
Time setting	rotary switch and potentiometer		
Time deviation	5 % - mechanical setting		
Repeat accuracy	0.2 % - set value stability		
Temperature coefficient	0.01 % / °C, at = 20 °C		
OUTPUT			
Number of contacts	1x changeover/SPDT (AgNi / Silver Alloy)	1x static contactless output (triac)	3x changeover/SPDT (AgNi / Silver Alloy)
Current rating	16 A / AC1	0.7 A	8 A / AC1
Breaking capacity	2500 VA / AC1, 240 W / DC		
Inrush current	30 A / <3 s	60 A / <10 ms	10 A / <3 s
Switching voltage	250 V AC1 / 24 V DC	x	250 V AC1 / 24 V DC
Min. breaking capacity DC	500 mW	x	500 mW
Output indication	multifunction red LED		
Voltage drop on switch	x	max. 0.9 V at I_{max}	x
Load on B1 terminal	x	Yes / I_{max} 0.7 A	x
Mechanical life	3×10^7	$>10^8$	3×10^7
Electrical life (AC1)	0.7×10^7	$>10^8$	0.7×10^7
CONTROL			
Power on control input	AC 0.025 - 0.2 VA / DC 0.1 - 0.7 W (UNI), AC 0.53 VA (AC 230 V), AC 0.025 - 0.2 VA (AC 12 - 240 V)		
Load between S-A2	Yes		
Control terminals	A1-S		
Glow tubes connetions	Yes	No	Yes
Max. amount of glow lamps connected to controlling input	UNI - glow lamps cannot connected / NO 230 V - max 20 psc (measured with glow lamp 0.68 mA 230 V AC)	glow lamps cannot connected/NO	UNI - glow lamps cannot connected / NO 230 V - max 20 psc (measured with glow lamp 0.68 mA 230 V AC)
Impulse length	min. 25 ms / max. unlimited	x	min. 25 ms / max. unlimited
Reset time	max. 150 ms	max. 250 ms	max. 150 ms
OTHER INFORMATION			
Operating temperature	-20 ... +55 °C		
Storage temperature	-30 ... +70 °C		
Electrical strength	4 kV (supply-output)	x	4 kV (supply-output)
Operating position	any		
Mounting	DIN rail EN 60715		
Protection degree	IP 40 from front panel / IP 20 teminals		
Overtoltage category	III.		
Pollution degree	2		
Terminal wire capacity	solid wire max. 2x 2.5 mm ² max. 1x4 mm ² / with sleeve max. 1x2.5 mm ² , 2x1.5 mm ²		
Standards	EN 61812-1, EN 61010-1		

Connection diagram



TRE 711

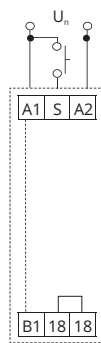

TRE 711 TO

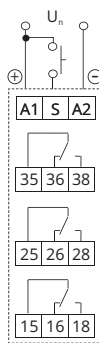

TRE 712

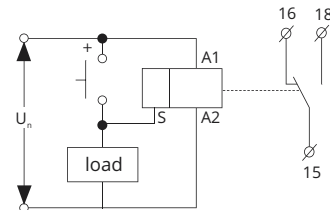

Possibility to connect load onto controlling input is possible to connect the load (e.g.: contactor) between terminals S-A2, without any interruption of correct relay function.

TIME RELAYS - MULTIFUNCTION TIME RELAY - TRE 711, TRE 712

Symbol

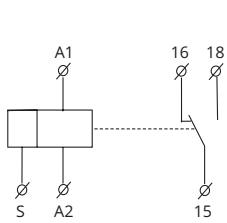

TRE 711

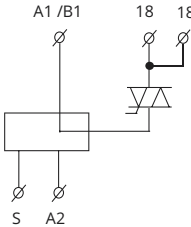

TRE 711 TO

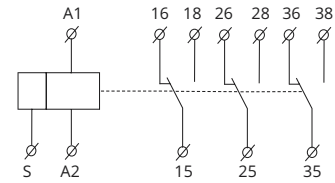

TRE 712

Functions



On Delay (Power On)

When the input voltage U is applied, timing delay t begins. Relay contacts R change state after time delay is complete. Contacts R return to their shelf state when input voltage U is removed. Trigger switch is not used in this function.



Single Shot

Upon application of input voltage U, the relay is ready to accept trigger signal S. Upon application of the trigger signal S, the relay contacts R transfer and the preset time t begins. During time-out, the trigger signal S is ignored. The relay resets by applying the trigger switch S when the relay is not energized.



Off Delay

When input voltage U is applied, relay contacts R change state immediately and timing cycle begins. When time delay is complete, contacts return to shelf state. When input voltage U is removed, contacts will also return to their shelf state. Trigger switch is not used in this function.

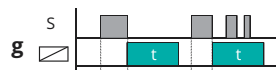

Single Shot Trailing Edge (Non-Retriggerable)

Upon application of input voltage U, the relay is ready to accept trigger signal S. Upon application of the trigger signal S, the relay contacts R transfer and the preset time t begins. At the end of the preset time t, the relay contacts R return to their normal condition unless the trigger switch S is opened and closed prior to time out t (before preset time elapses). Continuous cycling of the trigger switch S at a rate faster than the preset time will cause the relay contacts R to remain closed. If input voltage U is removed, relay contacts R return to their shelf state.



Repeat Cycle (Starting Off)

When input voltage U is applied, time delay t begins. When time delay t is complete, relay contacts R change state for time delay t. This cycle will repeat until input voltage U is removed. Trigger switch is not used in this function.

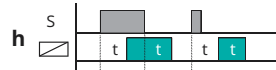

On/Off Delay

Input voltage U must be applied continuously. When trigger switch S is closed, time delay t begins. When time delay t is complete, relay contacts R change state and remain transferred until trigger switch S is opened. If input voltage U is removed, relay contacts R return to their shelf state.



Repeat Cycle (Starting On)

When input voltage U is applied, relay contacts R change state immediately and time delay t begins. When time delay t is complete, contacts return to their shelf state for time delay t. This cycle will repeat until input voltage U is removed. Trigger switch is not used in this function.

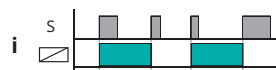

Latching relay

Input voltage U must be applied continuously. Output changes state with every trigger switch S closure. If input voltage U is removed, relay contacts R return to their shelf state.

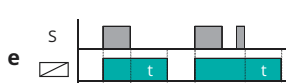

Off Delay (S Break)

Input voltage U must be applied continuously. When trigger switch S is closed, relay contacts R change state. When trigger switch S is opened, delay t begins. When delay t is complete, contacts R return to their shelf state. If trigger switch S is closed before time delay t is complete, then time is reset. When trigger switch S is opened, the delay begins again, and relay contacts R remain in their energized state. If input voltage U is removed, relay contacts R return to their shelf state.

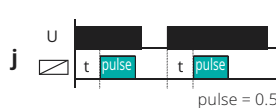

Pulse generator

Upon application of input voltage U, a single output pulse of 0.5 seconds is delivered to relay after time delay t. Power must be removed and reapplied to repeat pulse. Trigger switch is not used in this function.

Note:

1. Output contacts of TRE 712 do not allow switching of different phases or 3-phase voltages (voltage > 250 V).
2. When mounting into steal-plated switchboards, it is necessary to keep a safety distance of min. 3 mm from terminal's screws 35-36-38 and 25-26-28 towards the shutter of a switchboard.

TIME RELAYS - DIGITAL MULTIFUNCTIONAL TIME RELAY - TRE 811



TRE 811 - DIGITAL MULTIFUNCTION RELAY CAN BE USED FOR CONTROLLING LIGHTS, HEATING, MOTOR, PUMPS MACHINES AND APPLIANCES WHERE YOU NEED SET TIME FUNCTIONS.



FUNCTION DESCRIPTION

- 17 most used functions
- Thanks to digital display and settings you exact set required time (without any mechanical tolerance)
- Time range 0.1 s - 999 hours
- Universal power supply 24-240 V AC/DC brings you variability of powering
- 1x 8 A changeover contact
- Visible time function for non-authorized
- 1-MODULE, DIN rail mounting

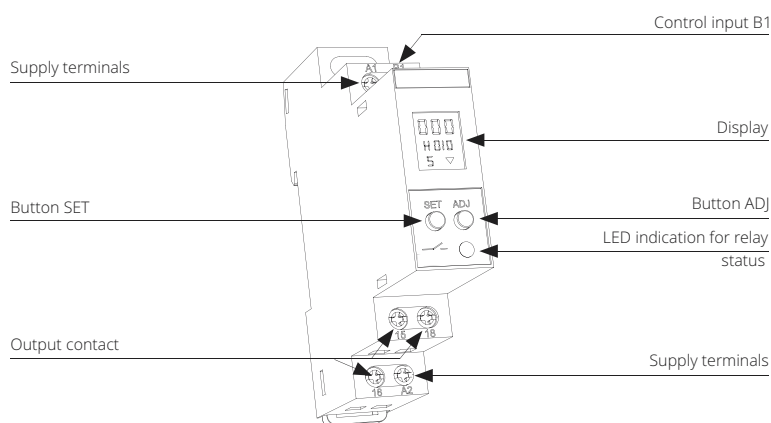

DESCRIPTION OF DISPLAYED ELEMENTS ON THE SCREEN

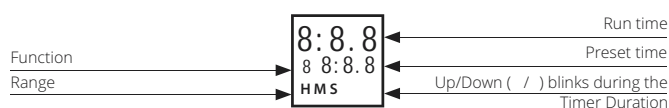

Type	Control supply (V)	Number of optput contacts	Time range	Ordering No.	Weight (g)	Packaging (pcs)
TRE 811 1 ZR UNI 10s	UNI	1	10s	786.053.082	85	1

TIME RELAYS - DIGITAL MULTIFUNCTIONAL TIME RELAY - TRE 811

Type	TRE 811
Number of functions	17
Supply terminals	A1 - A2
Voltage range	AC/DC 24 - 240 V (50 - 60 Hz)
Consumption (apparent / loss)	AC 1-4 VA / DC 1-3 W
Supply voltage tolerance	-15 %; +10 %
Time ranges	0.1 s - 999 hrs
Time setting	Buttons SET / ADJ
Repeat accuracy	± 0.5 % - of selected range
Variation in timing due to voltage change	± 2%
Temperature change	± 5%
OUTPUT	
Number of contacts	1x changeover/SPDT (AgNi)
Current rating	8 A / AC1
Breaking capacity	2000 VA / AC1, 192 W / DC
Inrush current	10 A / <3 s
Switching voltage	250 V AC1 / 24 V DC
Output indication	multifunction red LED
Mechanical life	2 x 10 ⁷
Electrical life (resistive)	1 x 10 ⁵
CONTROL	
Controlling terminals	A1 - B1
OTHER INFORMATION	
Operating temperature	-10 ... +55 °C
Storage temperature	-30 ... +70 °C
Isolation (between input and output)	2.5 kV
Operating position	any
Mounting	DIN rail EN 60715
Protection degree	IP 30 from front panel / IP 20 terminals
Oversvoltage category	III.
Pollution degree	2
Terminal wire capacity	solid wire max. 1x 2.5 mm ² or 2x1.5 mm ² / with sleeve max. 1x2.5 mm ²

9

Connection diagram

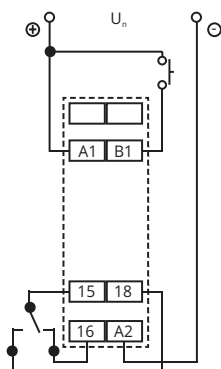



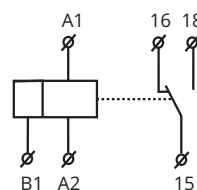





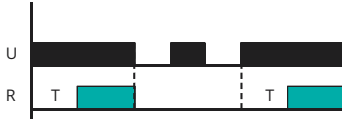

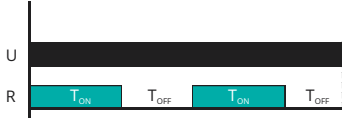
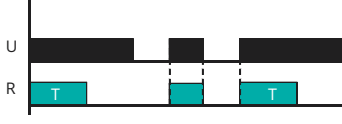
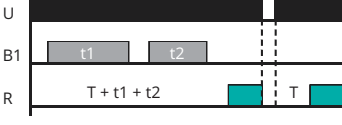
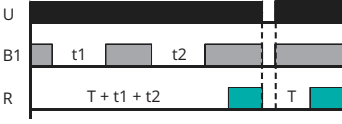
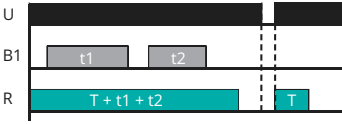
Symbol

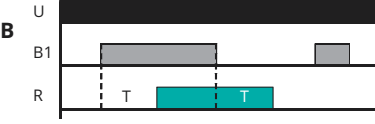

TECHNICAL DATA

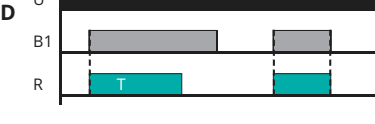
Functions

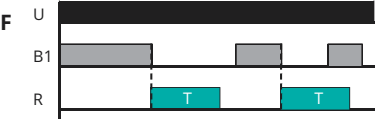
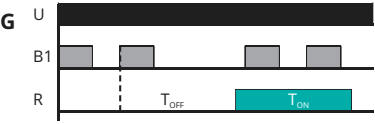
- 0**  **ON delay [0]**
Timing commences when supply is present. R energizes at the end of the timing period.
- 1**  **Cyclic OFF/ON {OFF Start, (Sym, Asym)} [1]**
T-ON and T-OFF can be same or different. The relay (R) keeps on changing its status till power is removed.
- 2**  **Cyclic ON/OFF {ON Start, (Sym, Asym)} [2]**
This function is quite similar to the function '1' but initially the relay(R) is ON for period T-ON af-ter the power is applied.
- 3**  **Impulse ON energizing [3]**
After power ON, R energizes and timing starts. R de-energizes after timing is over.
- 4**  **Accumulative delay ON signal [4]**
Time commences as supply is present and switch B1 is open. Closing switch B1 pauses timing. Timing resumes when switch B1 is opened again. R energizes at the end of timing.
- 5**  **Accumulative delay ON inverted signal [5]**
Time commences as supply is present and switch B1 is closed. Opening switch B1 pauses timing. Timing resumes when switch B1 is closed again. R energizes at end of timing.
- 6**  **Accumulative impulse ON signal [6]**
When supply is ON, R energizes. When switch B1 is closed timing is suspended and remains sus-pended till switch B1 is opened again. Interrupt-ing supply resets timer.
- 7**  **Signal ON delay [7]**
Permanent supply required. Timing starts when switch B1 is closed. R energizes at end of timing period and de-energizes when B1 is opened.
- 8**  **Inverted signal ON delay [8]**
Timing will commence when supply is present and switch B1 is open. R energizes after timing. If B1 is closed during timing period, timing resets to the beginning of cycle.
- 9**  **Signal OFF delay [9]**
Permanent supply is required. R energizes when switch B1 is closed. Timing commences after S is opened and then the relay de-energizes.
- A**  **Impulse ON/OFF [A]**
Permanent supply is required. R energizes for the timing period when B1 is opened or closed. When timing commences, changing state of B1 does not affect R but resets timer.
- B**  **Signal OFF/ON [B]**
When switch B1 is closed or opened for preset time T, the relay changes its state after time duration T.
- C**  **Leading edge impulse1 [C]**
A permanent supply is needed. When B1 is closed, output relay energizes until timing irrespective of any further action of B1.
- D**  **Leading edge impulse2 [D]**
Permanent supply is required. When switch B1 is closed, and remains closed output relay energizes until timing is over. If B1 is opened during timing, R resets.
- E**  **Trailing edge impulse1 [E]**
Permanent supply required. When B1 is opened, R energizes and de-energizes when timing is over. If B1 is closed during timing R resets.
- F**  **Trailing edge impulse2 [F]**
Permanent supply is required. When switch B1 is opened, R energizes and will de-energize when timing is over. If B1 is pulsed during timing period it will have no effect on R.
- G**  **Delayed impulse [G]**
When switch B1 is closed, TOFF starts. Relay energizes at the end of TOFF period. Then, TOFF starts irrespective of signal level and relay de-energizes at the end of TON period.

TIME RELAYS - PLUG-IN TIME RELAY - CRT 151H, CRT 160H, CRT 161H



CRT 151H, CRT160H, CRT161H - MULTIFUNCTION TIME RELAYS ARE EQUIVALENTS BY MODULE TYPES OF RELAY, DESIGNED TO STANDARDIZED PLUMP 11 OR 8 PIN SOCKET.

FUNCTION DESCRIPTION

- Pin type enables easy changing, replacement older type of relays (pin-compatible) or easy changing auxiliary relay for time relays
- Multifunction time relay CRT 151H, CRT 161H
 - 8 or 11 pin type
 - 10 time functions, time scale from 0.1 s to 10 days is divided into 10 ranges
 - output contact 1x 16 A / 4000 VA, 250 V Ac1
- Multifunction time relay CRT 160H
 - 11 pin type
 - 10 time functions, time scale from 0,1 s to 10 days is divided into 10 ranges
 - output contact 2x 8 A / 2000 VA, 250 V Ac1
- Universal supply voltage AC/DC 12 - 240 V
- Output indication: multif. red LED, flashing at certain states
- PLUG-IN relays

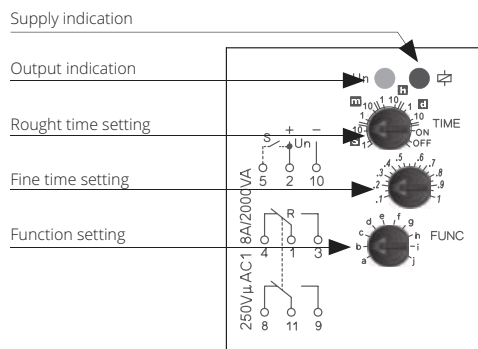

Functions

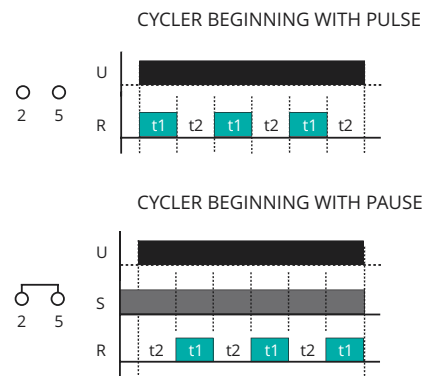

Note: Functions of CRT 151H, CRT 160h and CRT 161H are identical with TRE 711.

Type	Control supply (V)	Number of optput contacts	Time range	Ordering No.	Weight (g)	Packaging (pcs)
CRT 151H 1 UNI	UNI	1	0.1s - 10 days	786.053.076	57	1
CRT 160H 2 UNI	UNI	2	0.1s - 10 days	786.053.073	58	1
CRT 161H 1 UNI	UNI	1	0.1s - 10 days	786.053.073	57	1

TIME RELAYS - PLUG-IN TIME RELAY - CRT 151H, CRT 160H, CRT 161H

Type	CRT 151H	CRT 160H	CRT 161H
Number of functions		10	
Supply	pins 2 and 7	pins 2 and 10	pins 2 and 10
Voltage range		AC/DC 12 - 240 V (AC 50 - 60 Hz)	
Burden		AC 0.7 - 3 VA / DC 0.5 - 1.7 W	
Supply voltage tolerance		-15 %; +10 %	
Supply indication		green LED	
Time ranges		0.1 s - 10 days	
Time setting		rotary switch and potentiometer	
Time deviation		5 % - mechanical setting	
Repeat accuracy		0.2% - set value stability	
Temperature coefficient		0.01 % / °C, at = 20 °C	
OUTPUT			
Number of contacts	1x changeover/SPDT (AgNi / Silver Alloy)	2x changeover/DPDT (AgNi / Silver Alloy)	1x changeover/SPDT (AgNi / Silver Alloy)
Current rating	16 A / AC1	8 A / AC1	16 A / AC1
Breaking capacity	4000 VA / AC1, 384 W / DC	2000 VA / AC1, 192 W / DC	4000 VA / AC1, 384 W / DC
Inrush current	30 A / <3 s	10 A / <3 s	30 A / <3 s
Switching voltage		250 V AC1 / 24 V DC	
Min. breaking capacity DC		500 mW	
Output indication		multifunction red LED	
Mechanical life		3 x 10 ⁷	
Electrical life (resistive)		0.7 x 10 ⁵	
CONTROL			
Control voltage		in the supply voltage range	
Control power input		AC 0.025 - 0.2 VA / DC 0.1 - 0.7 W	
Load between 5 - 10		Yes	
Glow-tubes		No	
Control terminals		2 - 5	
Max. capacity of cable control (without connected glow-lamps)		0.1 µF	
Impulse length		min. 25 ms / max. unlimited	
Reset time		max. 150 ms	
OTHER INFORMATION			
Operating temperature		-20 ... +55 °C	
Storage temperature		-30 ... +70 °C	
Electrical strength		2.5 kV	
Operating position		any	
Mounting		DIN rail EN 60715	
Protection degree		IP 40 from front panel	
Overvoltage category		III.	
Pollution degree		2	

Time ranges of CRT 151H, CRT 160H and CRT 161H are identical with TRE 711.

Connection diagram

CRT 161 (11 pins)

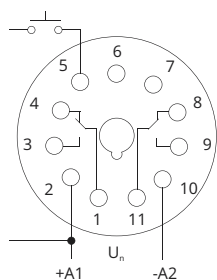

CRT 151 (8 pins)

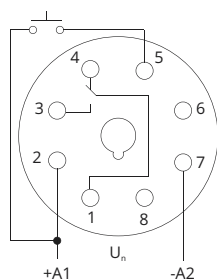

Symbol

CRT 151 (8 pins)

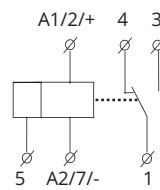

CRT 161 (11 pins)

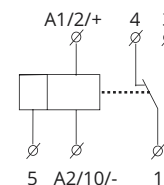

CRT 160H

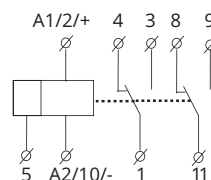

Note: Polarity- outputs/number on module/on socket.

TIME RELAYS - PROGRAMMABLE DIGITAL RELAY - NDR-2A, NDR-2B



NDR 2A, NDR 2B - MULTIFUNCTION PROGRAMMABLE DIGITAL RELAY WITH 4 DIGIT RED LED DISPLAY.



FUNCTION DESCRIPTION

- Control and setting are done by 3 buttons, user-friendly menu, absolute accuracy in timer setting, time countdown on a display, galvanically separated START and STOP control inputs with UNI supply
- Thanks to its complexity, it is possible to program also more demanding time functions by using 2 independent times.
- 2 independent times, with combination of 2 inputs and 2 outputs
- NDR 2A: 16 functions, choice of functions of the other relay, 30 memory places for most frequently used times
- NDR 2B: 10 functions, 1 output of 10 functions can be assigned to each relay = 2 relays in one device
- 2 independent times in range: 0.01 s - 100 hrs
- 3-MODULE, DIN rail mounting

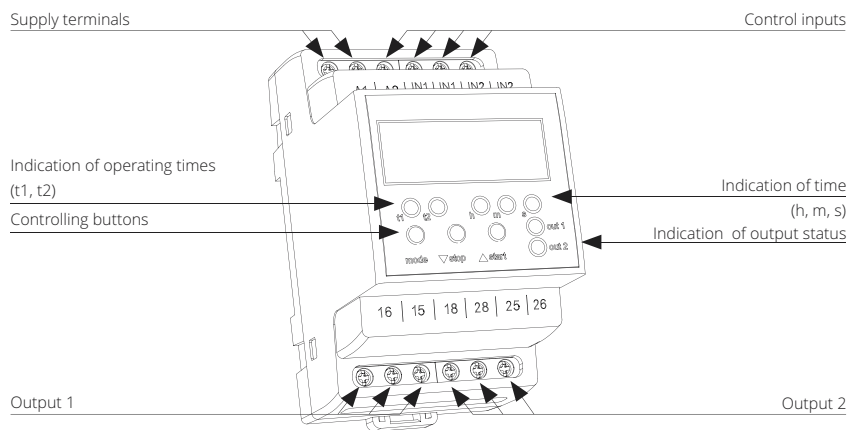

Type	Control supply (V)	Number of optput contacts	Time range	Ordering No.	Weight (g)	Packaging (pcs)
NDR 2A UNI	UNI	2	0.01s - 100 hrs	786.050.826	145	1
NDR 2B 230 V	230	2	0.01s - 100 hrs	786.050.841	140	1

TIME RELAYS - PROGRAMMABLE DIGITAL RELAY - NDR-2A, NDR-2B

Type	NDR 2A	NDR 2B
Number of functions	16	10
Supply terminals	A1 - A2	
Voltage range	AC/DC 12 - 240 V (AC 50 - 60 Hz)	-
Burden	AC 0.5 - 2.5 VA / DC 0.4 - 2.5 W	-
Voltage range	-	AC 230 V / 50 - 60 Hz
Consumption (apparent / loss)	-	AC max. 16 VA / 2.5 W
Supply voltage tolerance	-15 %; +10 %	
Time ranges	0.01 s - 100 hrs	
Repeat accuracy	± 0.2 % - set value stability	
Temperature coefficient	0.01 % / °C, at = 20 °C	
OUTPUT		
Number of contacts	2x changeover/SPDT (AgNi / Silver Alloy))	
Current rating	16 A / AC1	
Breaking capacity	4000 VA / AC1, 384 W / DC	
Inrush current	30 A / <3 s	
Switching voltage	250 V AC1 / 24 V DC	
Output indication	red LED	
Mechanical life	3 x 10 ⁷	
Electrical life (resistive)	0.7 x 10 ⁵	
CONTROL		
Control input burden	AC 0.01 - 0.25 VA (UNI), AC 0.25 VA (230 V)	
Glow lamps	No	
Control impulse length	min. 1 ms / max. unlimited	
Reset time	max. 200 ms	
Display colour	red	
Number and height of digits	4 positions with separating colon, height 10 mm	
Luminance	2200 - 3800 ucd	
Light wavelenght	635 nm	
Brightness setting	range 20 - 100 % in 10 steps adjustable	
Memory - memory locations	30 (NDR 2A) / 20 (NDR 2B) for times ranges + service function	
Data stored for	min. 10 years	
OTHER INFORMATION		
Operating temperature	-20 ... +55 °C	
Storage temperature	-30 ... +70 °C	
Electrical strenght	4 kV (supply - output)	
Operating position	any	
Mounting	DIN rail EN 60715	
Protection degree	IP 40 from front panel / IP 20 teminals	
Overvoltage category	III.	
Pollution degree	2	
Terminal wire capacity	solid wire max. 1x 2.5 mm ² or 2x1.5 mm ² / with sleeve max. 1x1.5 mm ²	
Standards	EN 61812-1, EN 61010-1	

Connection diagram

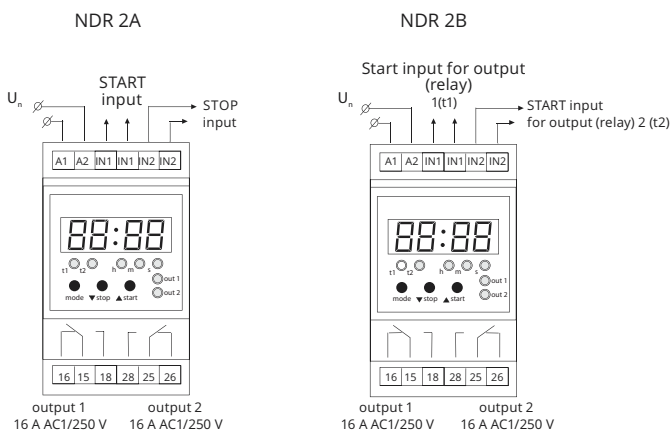

Symbol

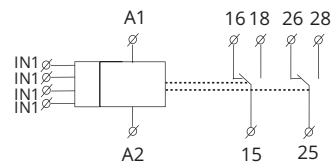

Time data:

Time range	0.01 s - 99 hrs 59 min 59 s 99 ss
Min. time step	0.01 s
Time deviation	0.01 % of set value
Setting error	0 %
Setting, reset accuracy	100 %
Digital places	selected via program

Functions

FUNCTIONS FOR NDR 2A AND NDR 2B

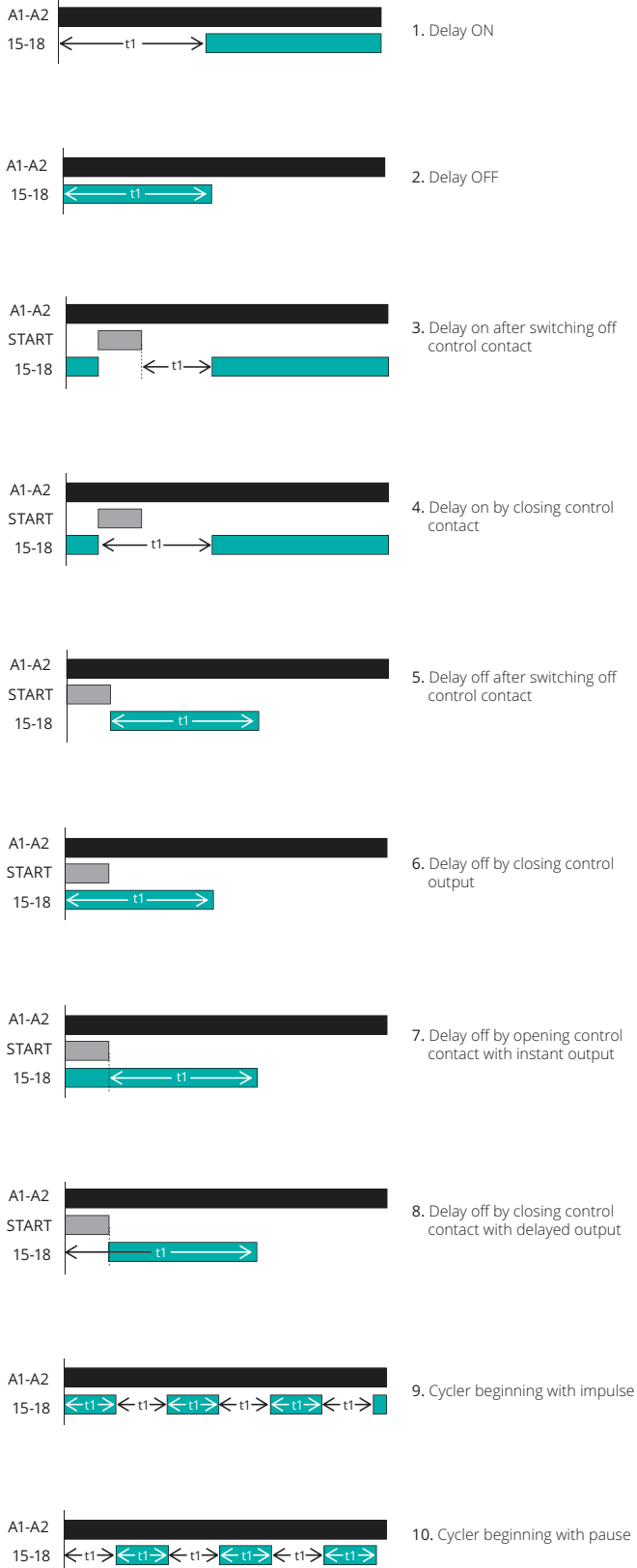

FUNCTIONS FOR NDR 2A

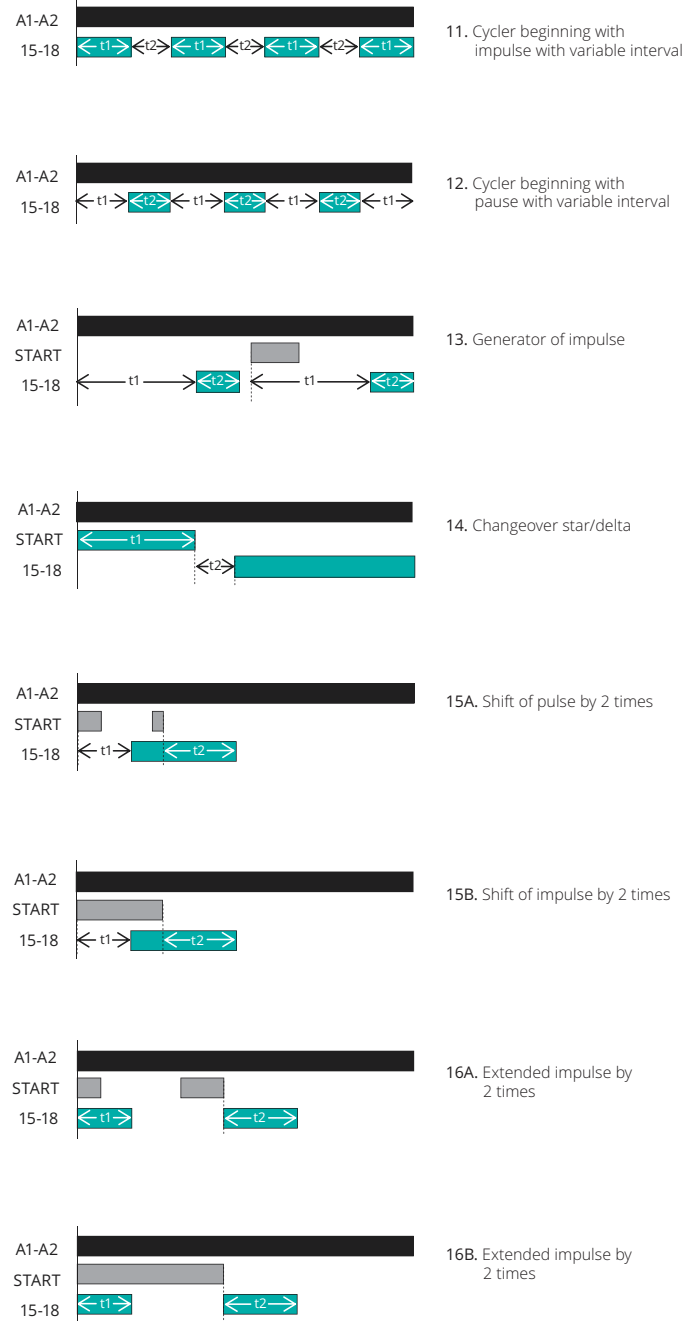

Recommendation:

NDR-2B is replacing by 2 simple time relays = 2 in one.

TIME RELAYS

1-MODULE DESIGN

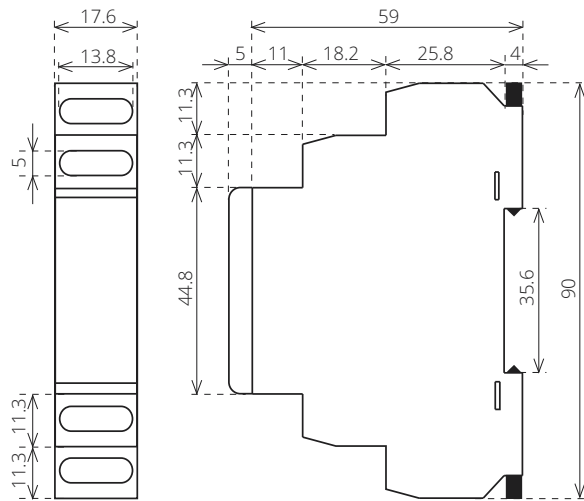

3-MODULE DESIGN

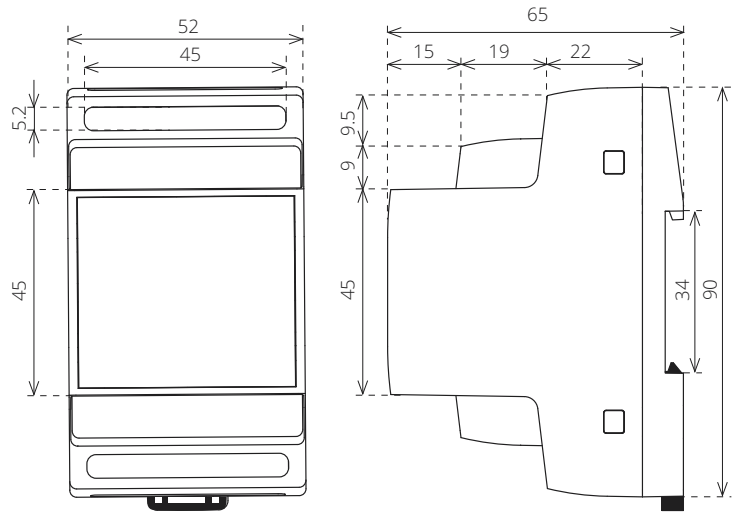

TRE 811

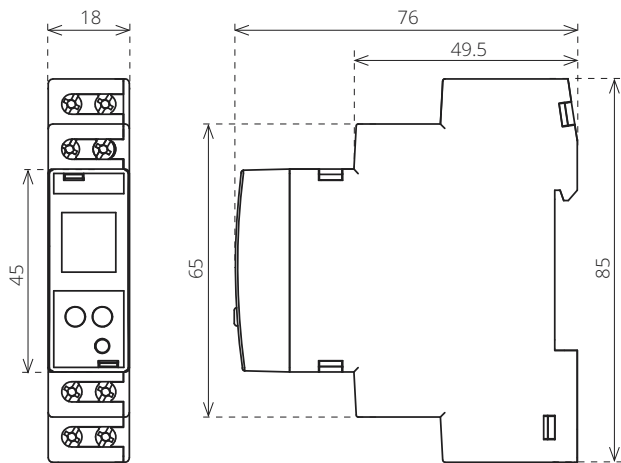

CRT 151H, CRT 160H, CRT 161H

