



Automation components
Bauteile für Automatisierung

POWER RELAYS INDUSTRIESRELAIS

PR 45, 46
TRP 614, 624, 66, 67
TRP 651, 652



Universal power relays

Power relays for industrial universal purpose with 1, 2, 3 or 4 change-over contacts, available in AC or DC coils with plug-in terminals for sockets or for circuit.

The relays are dustproof with IP 40 according to EN 60 with insulation parts from nonflammable material.

Main characteristic

- Monostable, neutral relays
- DC or AC coils
- High switching power
- 1, 2, 3 or 4 change-over contacts
- 1, 2 or 3 make contacts with approx. 3 mm contact distance (only TRP 66/67)
- Sockets and accessories
- VDE, UL approval, CE

Universalindustrialrelais

Relais für den Universaleinsatz mit wahlweise 1, 2, 3 oder 4 Umschaltkontakten.

Lieferbar mit Wechselstrom- oder Gleichstromerregung als steckbares Relais für Sockels oder für gedruckte Schaltungen. Die Relais sind staubgeschützt und entsprechen Schutzart IP 40 nach EN 60529. Die Isolierteile sind aus selbstverlöschenden Kunststoffen gefertigt.

Hauptmerkmale

- Monostabile, neutrale Relais
- Gleich oder Wechselstromerregung
- Hohe Schaltleistung
- 1, 2, 3 oder 4 Umschaltkontakt
- 1, 2 oder 3 Arbeitskontakt mit ca. 3 mm Kontaktdistanz (nur TRP 66/67)
- Sockelzubehör
- VDE, UL, Zulassung, CE

RELAY	RELAY MOUNTING	RELAY CONNECTION	ACCESSORIES
PR 45 – relay with 1, 2 or 3 CO contacts	- to the socket - with two screws B2.2 x 6.5 DIN7971 directly via cover or via bracket TLK 1041 to the plate - with adapter TLK 1042 on the rail 35 mm - via socket on the rail or plate	- for faston terminals 2.8 x 0.8 mm - direct soldering of wire to the terminals of relay - via socket - via socket on printed circuit - via socket	bracket TLK 1041 adapter TLK 1042 socket TLK 1141 socket TLK 1143 socket TLK 1441
PR 46 – relay with 1, 2 or 3 contacts for printed circuits	- on printed circuit board	- through printed circuit	
TRP 614 – relay with 4 CO contacts	- to the socket - with two screws B2.2 x 6.5 DIN7971 directly via cover or via bracket TLK 1041 to the plate - with adapter TLK 1042 on the rail 35 mm - via socket on the rail or plate	- for faston terminals 2.8 x 0.8 mm - direct soldering of wire to the terminals of relay - via socket - via socket on printed circuit - via socket	bracket TLK 1041 adapter TLK 1042 socket TLK 1161 socket TLK 1163 socket TLK 1461
TRP 624 – relay with 4 CO contacts for printed circuits	- on printed circuit board	- through printed circuit	
TRP 66 – relay with 1, 2 or 3 CO contacts or 1, 2, 3 make contacts with contact distance approx. 3 mm	- with two screws B2.2 x 6.5 DIN7971 directly via cover or via bracket TLK 1041 to the plate - with adapter TLK 1042 on the rail 35 mm	- for faston terminals 4.8 x 0.5 mm - direct soldering of wire to the terminals of relay	bracket TLK 1041 adapter TLK 1042
TRP 67 – equal to TRP 66 but for printed circuits	- on printed circuit board	- through printed circuit	
TRP 651 – relay with one CO contacts for current up to 25 A TRP 652 – relay with two CO contacts for current up to 16 A	- with two screws B2.2 x 6.5 DIN7971 directly via cover or via bracket TLK 1041 to the plate - with adapter TLK 1042 on the rail 35 mm	- for faston terminals 6.3 x 0.8 mm - direct soldering of wire to the terminals of relay	bracket TLK 1041 adapter TLK 1042

RELAIS	RELAIS BEFESTIGUNG	ANSSCHLUSSART	ZUBEHÖR
PR 45 – Relais mit 1, 2 oder 3 Wechsler	- auf Sockel - mit zwei Schrauben B2,2 x 6,5 DIN 7971 direkt über Deckel oder über Befestigungskonsolle TLK 1041 auf Platte - mit Schnappvorrichtung TLK 1042 auf Schiene 35 mm - über Sockel auf Schiene oder Platte	- für Fastonanschlüsse 2,8 x 0,8 mm - Drahtlötung direkt auf Anschlüsse - über Sockel - über Sockel auf gedruckte Schaltung - über Sockel	Befestigungskonsolle TLK 1041 Schnappvorrichtung TLK 1042 Sockel TLK 1141 Sockel TLK 1143 Sockel TLK 1441
PR 46 – Relais mit 1, 2 oder 3 Wechsler für gedruckte Schaltung	- auf gedruckte Schaltung	- durch gedruckte Schaltung	
TRP 614 – Relais mit 4 Wechsler	- auf Sockel - mit zwei Schrauben B2,2 x 6,5 DIN 7971 direkt über Deckel oder über Befestigungskonsolle TLK 1041 auf Platte - mit Schnappvorrichtung TLK 1042 auf Schiene 35 mm - über Sockel auf Schiene oder Platte	- für Fastonanschlüsse 2,8 x 0,8 mm - Drahtlötung direkt auf Anschlüsse - über Sockel - über Sockel auf gedruckte Schaltung - über Sockel	Befestigungskonsolle TLK 1041 Schnappvorrichtung TLK 1042 Sockel TLK 1161 Sockel TLK 1163 Sockel TLK 1461
TRP 624 – Relais mit 4 Wechsler für gedruckte Schaltung	- auf gedruckte Schaltung	- durch gedruckte Schaltung	
TRP 66 – Relais mit 1, 2 oder 3 Wechsler der 1, 2, 3 Arbeitskontakt mit Kontaktdistanz ca. 3 mm	- mit zwei Schrauben B2,2 x 6,5 DIN 7971 direkt über Deckel oder über Befestigungskonsolle TLK 1041 auf Platte - mit Schnappvorrichtung TLK 1042 auf Schiene 35 mm	- für Fastonanschlüsse 4,8 x 0,5 mm - Drahtlötung direkt auf Anschlüsse	Befestigungskonsolle TLK 1041 Schnappvorrichtung TLK 1042
TRP 67 – gleich TRP 66 aber für gedruckte Schaltung	- auf gedruckte Schaltung	- durch gedruckte Schaltung	Befestigungskonsolle TLK 1041 Schnappvorrichtung TLK 1042
TRP 651 – Relais mit 1 Wechsler für Strom bis 25 A TRP 652 – Relais mit 1 Wechsler für Strom bis 16 A	- mit zwei Schrauben B2,2 x 6,5 DIN 7971 direkt über Deckel oder über Befestigungskonsolle TLK 1041 auf Platte - mit Schnappvorrichtung TLK 1042 auf Schiene 35 mm	- für Fastonanschlüsse 6,3 x 0,8 mm - Drahtlötung direkt auf Anschlüsse	

Technical data Contact data

Relay type:	PR 45 PR 46	TRP 614 TRP 624	TRP 66 TRP 67	TRP 652	TRP 651
Contact material:	AgNi 10				
Rated current:	10 A	10 A	10/16 A	16 A	25 A
Max. switch-on current: (4 s, 10% duty cycle)	20 A	20 A	20/32 A	32 A	50 A
Max. operating voltage:	250 V _{AC}		400/250 V _{AC}	250 V _{AC}	
Max. switching power:	2500 VA	2500 VA	4000 VA	4000 VA	6000 VA
Min. switching load:	12 V _{AC} 100mA				
Contact resistance: (New relay)	≤ 100mΩ (measuring method CA 3, IEC 61810-7)				
Max. operating frequency:	1000 operat./h at rated load 36000 operat./h at min. load				
Mechanical life:	> 10 ⁷ operating				
Electrical life:	see diagram				

Coils

Coil rated voltage U _n (V)	Coil resistance at 20°C			Operative voltage range at 20°C		
	DC	50Hz	60Hz	Operate U _{op} ≤(V)	U _{max} DC ≤(V)	U _{max} AC ≤(V)
	R _n (Ω) ± 10%			U _{op} ≤(V)		
6	28	5.7	5	4.8	9	9.5
12	110	25	20	9.6	18	19
24	440	100	80	19.2	36	38
48	1740	400	320	38.4	73	76
60	2750	630	510	48	91	95
110	9000	2000	1750	88	168	174
220	36000	7700	7000	176	336	349
230	39000	8800	7500	184	351	365
380*		21500		304	579	603

* only TRP 66/67

Coil data at ambient temperature 20 °C

Rated power: app. 1.3 W; 2 VA
 Operate power: app. 0.8 W; 1.2 VA
 Max. coil temperature: 155° C
 Thermal coil temperature: 50 K/W
 Operate voltage: U_{op} ≤ 80% U_n
 Release voltage: U_{re} ≥ 10% U_n (DC);
 U_{re} ≥ 15% U_n (AC)
 Operative range: I EN 61810-1

Operative voltage range Betriebsspannungsbereich

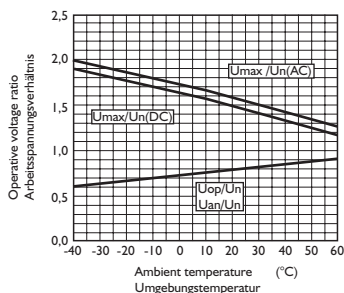

Other data

Test voltage (1 min.)
 contact – coil: ≥ 2 kV_{rms}, 50 Hz
 ≥ 2.5 kV_{rms} – TRP 66, 67
 contact – contact: ≥ 1 kV_{rms}, 50 Hz
 only make contact: ≥ 2.5 kV_{rms} – TRP 66, 67
 between contact sets: ≥ 2 kV_{rms}, 50 Hz
 Operate time at U_n: ≥ 20 ms

Technische Angaben Kontaktseite

Relais tip:	PR 45 PR 46	TRP 614 TRP 624	TRP 66 TRP 67	TRP 652	TRP 651
Kontaktmaterial:	AgNi 10				
Nennstrom:	10 A	10 A	10/16 A	16 A	25 A
Max. Einschaltstrom: (4 s, 10% ED)	20 A	20 A	20/32 A	32 A	50 A
Max. Schaltspannung:	250 V _{AC}		400/250 V _{AC}	250 V _{AC}	
Max. Schaltleistung:	2500 VA	2500 VA	4000 VA	4000 VA	6000 VA
Min. Schaltbelastung:	12 V _{AC} 100mA				
Kontaktwiderstand: (Neuzustand)	≤ 100mΩ (Messmethode CA 3, IEC 61810-7)				
Max. Schalthäufigkeit:	1000 Schaltsp./h bei Nennlast 36000 Schaltsp./h bei min. Last				
Mechanische Lebensdauer:	> 10 ⁷ Schaltspiele				
Elektrische Lebensdauer:	Siehe Diagramm				

Wicklungen

Wicklungs-nennspannung U _n (V)	Wicklungswiderstand bei 20°C			Betriebsspannungsbereich bei 20°C		
	DC	50Hz	60Hz	Ansprech U _{an} ≤(V)	U _{max} DC ≤(V)	U _{max} AC ≤(V)
	R _n (Ω) ± 10%			U _{an} ≤(V)		
6	28	5.7	5	4.8	9	9.5
12	110	25	20	9.6	18	19
24	440	100	80	19.2	36	38
48	1740	400	320	38.4	73	76
60	2750	630	510	48	91	95
110	9000	2000	1750	88	168	174
220	36000	7700	7000	176	336	349
230	39000	8800	7500	184	351	365
380*		21500		304	579	603

* nur TRP 66/67

Wicklungsangaben bei Umgebungstemp. 20 °C

Nennleistung: app. 1.3 W; 2 VA
 Ansprechleistung: app. 0.8 W; 1.2 VA
 Max. Wicklungstemperatur: 155° C
 Wärmewiderstand: 50 K/W
 Ansprechspannung: U_{op} ≤ 80% U_n
 Rückfallspannung: U_{rü} ≥ 10% U_n (DC);
 U_{rü} ≥ 15% U_n (AC)
 Arbeitsbereich: I EN 61810-1

Reduction factor Reduktionsfaktor

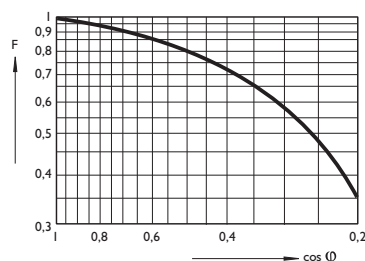

Operations eff. =
operations (cos φ = 1) × F

Schaltzahl eff. =
Schaltzahl (cos φ = 1) × F

Sonstige Daten

Prüfspannung (1 min.)
 Kontakt - Wicklung: ≥ 2 kV_{eff}, 50 Hz
 ≥ 2.5 kV_{rms} – TRP 66, 67
 Kontakt - Kontakt: ≥ 1 kV_{eff}, 50 Hz
 nur Arbeitskontakt: ≥ 2.5 kV_{rms} – TRP 66, 67
 zwischen Kontaktsätzen: ≥ 2 kV_{eff}, 50 Hz
 Ansprechzeit bei U_n: ≥ 20 ms

Release time:	≤ 15 ms
Bounce time:	≤ 5 ms
Insulation resistance (500 VDC):	> 10 ³ MΩ
Vibration resistance (10-55 Hz):	3 g _n
Shock resistance (11 ms)	
functional:	10 g _n
destructive:	100 g _n
Ambient temperature	
for operating:	-25 °C to + 50 °C
for storage:	-40 °C to + 80 °C
Protection degree:	IP 40, EN 60529
Insulation class:	3-250, IEC 60664-1
Mounting position:	as desired, relay distance
	10 mm
Relay weight:	80 g

Rückfallzeit:	≤ 15 ms
Prellzeit:	≤ 5 ms
Isolationswiderstand (500 VDC):	> 10 ³ MΩ
Vibrationsfestigkeit (10-55 Hz):	3 g _n
Stoßfestigkeit (11 ms)	
zuverlässiges Schalten:	10 g _n
Beschädigungsgrenze:	100 g _n
Umgebungstemperatur	
in Betrieb:	-25 °C to + 50 °C
bei Lagerung:	-40 °C to + 80 °C
Schutzklasse:	IP 40, EN 60529
Isolationsgruppe:	3-250, IEC 60664-1
Einbaulage:	beliebig, Montageabstand
	10 mm
Gewicht:	80 g

Electrical life, resistive AC load
Kontaktlebensdauer bei ohmscher AC Belastung

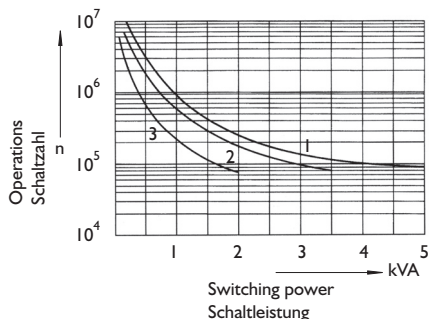

- 1 – Relay TRP 651
 - 2 – Relay TRP 652
 - 3 – Relays PR 45/46 and TRP 66/67
-
- 1 – Relais TRP 651
 - 2 – Relais TRP 652
 - 3 – Relais PR 44/45 und TRP 66/67

Max. switching capacity, DC load
Gleichstrom-Lastgrenzkurve Belastung

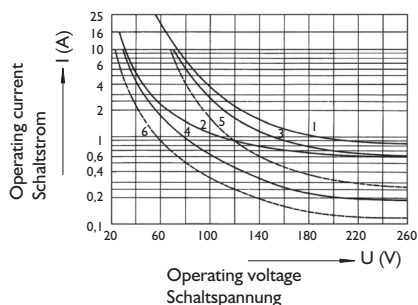

- 1 – Relay TRP 651, resistive load
- 2 – Relay TRP 652, resistive load
- Relays TRP 45/46 and TRP 61/62/66/67
- 3 – two contacts in series, resistive load
- 4 – one contact, resistive load
- 5 – two contacts in series, inductive load L/R = 40 ms
- 6 – one contact, inductive load L/R = 40 ms

- 1 – Relais TRP 651, ohmsche Belastung
- 2 – Relais TRP 652, ohmsche Belastung
- Relais TRP 45/46 und TRP 61/62/66/67
- 3 – zwei Kontakte in Serie, ohmsche Belastung
- 4 – ein Kontakt, ohmsche Belastung
- 5 – zwei Kontakte in Serie, induktive Belastung L/R = 40 ms
- 6 – ein Kontakt, induktive Belastung L/R = 40ms

Ordering data for PR 45/46, TRP 61/62

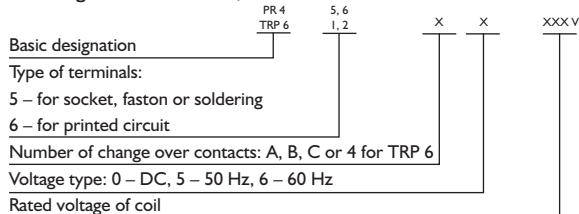

Bestellangaben für PR 45/46, TRP 61/62

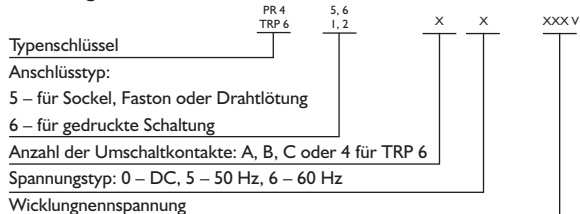

Ordering data for TRP 66, TRP 67

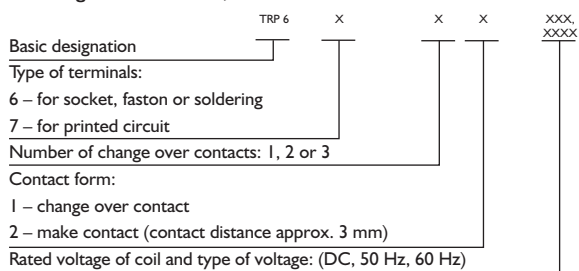

Bestellangaben für TRP 66, TRP 67

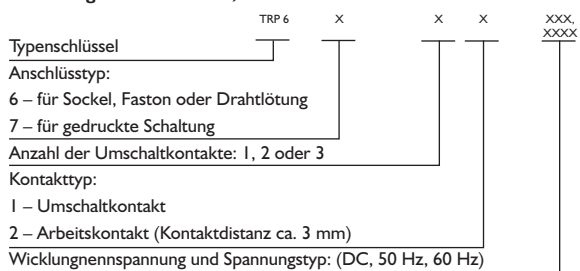

Data subject to alteration

Änderungen vorbehalten

Dimensions and terminals arrangement Abmessungen und Anschlussbelegung

PR 45

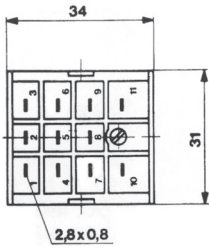

PR 46

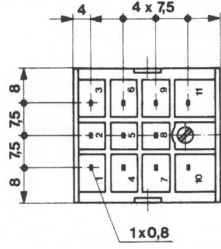

TRP 614

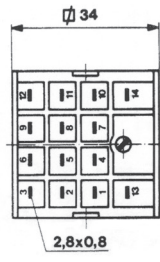

TRP 624

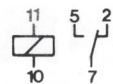
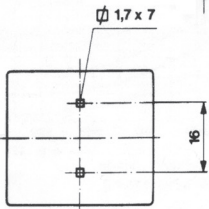
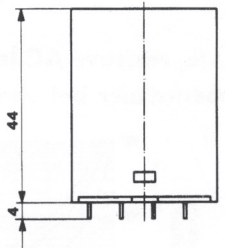
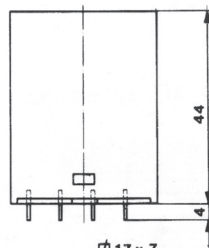
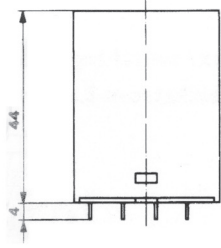
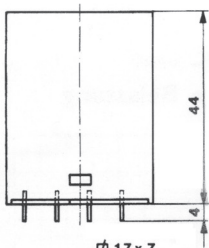
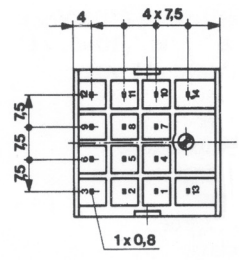

PR 4xAx

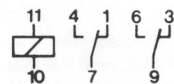

PR 4xBx

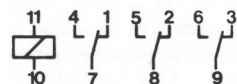

TRP 4xCx

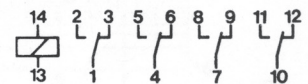
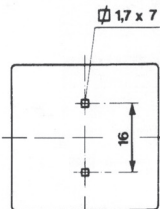

TRP 6x4x

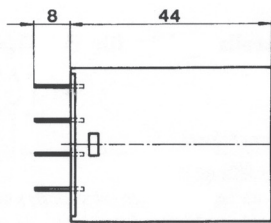
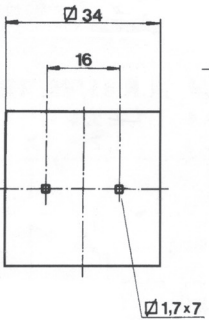

TRP 65

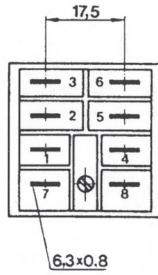

TRP 65I

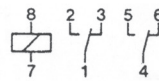

TRP 652

TRP 66, TRP 67

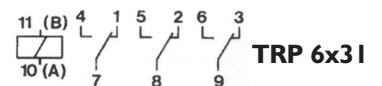
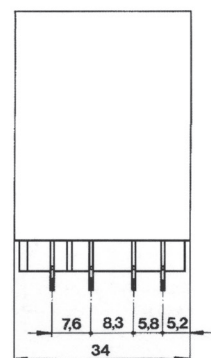
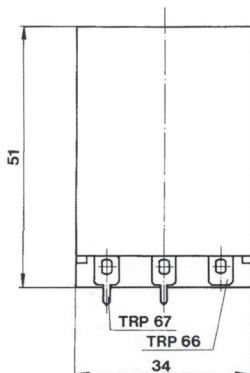
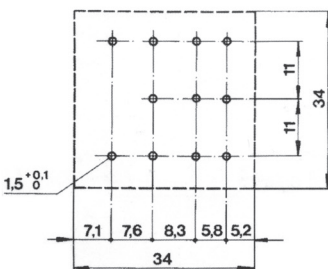

TRP 6x3I

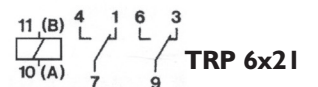

TRP 6x2I

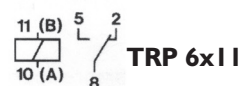

TRP 6x1I

Accessories Zubehör

Bracket Befestigungskonsole

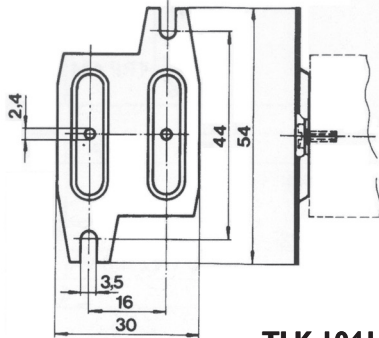

TLK 1041

Adapter Schnappvorrichtung

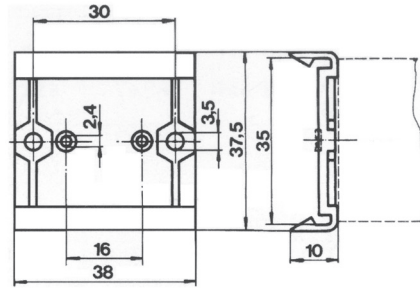

TLK 1042

Sockets Sockels

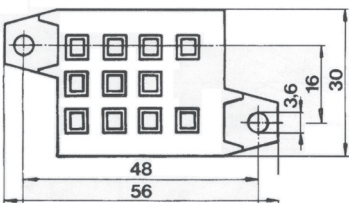
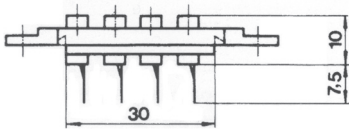

TLK 1141
for/für
PR 45

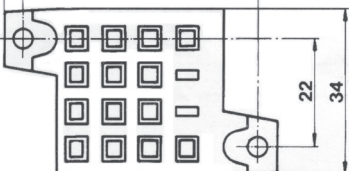

TLK 1161 for/für TRP 614

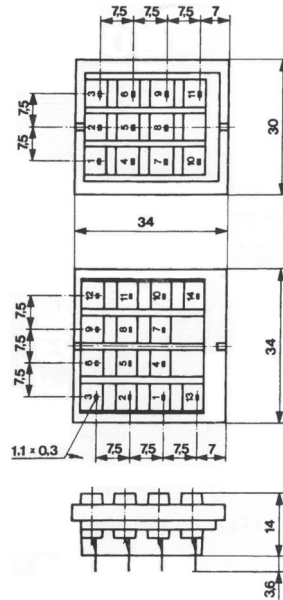

TLK 1143
for/für
PR 45

TLK 1163
for/für
TRP 614

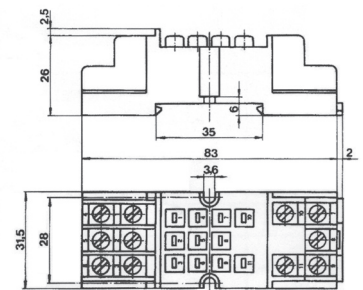

TLK 1441 for/für PR 45

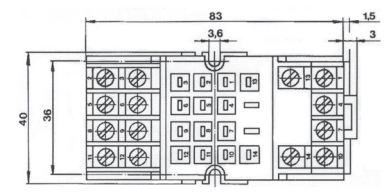

TLK 1461 for/für TRP 614

Safety clip Haltefeder

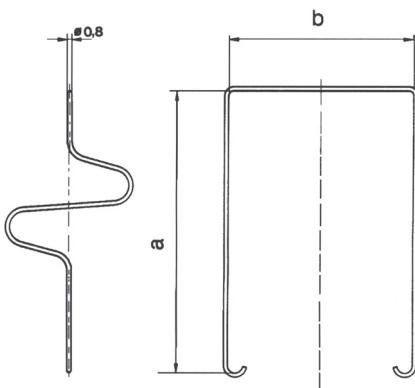

Relays PR 45 and TRP 614

a	b	for sockets
42	36	TLK 1141, TLK 1161
59	32	TLK 1441
55	36	TLK 1461

Relais PR 45 und TRP 614

a	b	für Sockel
42	36	TLK 1141, TLK 1161
59	32	TLK 1441
55	36	TLK 1461